

27 II/28 II

Digital Multimeters

Calibration Information

Introduction

Warning

To avoid electric shock or injury, do not perform the performance tests or calibration adjustment procedures unless qualified to do so.

The information provided in this document is for the use of qualified personnel only.

The 27 II/28 II Calibration Information provides adjustment and performance test procedures for the Fluke Model 27 II and 28 II Digital Multimeters (hereafter known as the Meter).

This document includes the following information:

- Safety Information and International Electrical Symbols (page 2)
- Specifications (page 5)
- Testing the Fuse (page 9)
- Cleaning (page 9)
- Performance Tests (page 11)
- Calibration Adjustment (page 19)
- Replacement Parts (page 24)
- Complete Warranty (page 27)

See the 27 II/28 II Users Manual for complete operating instructions.

Contact Information

To contact Fluke, call one of the following telephone numbers:

USA: 1-888-99-FLUKE (1-888-993-5853)

Canada: 1-800-36-FLUKE (1-800-363-5853)

Europe: +31 402-675-200

Japan: +81-3-3434-0181

Singapore: +65-738-5655

Anywhere in the world: +1-425-446-5500

Or, visit Fluke's Web site at www.fluke.com.

To register your product, visit register.fluke.com

Safety Information

"Warning" and "Caution" Statements

A **Warning** identifies hazardous conditions and actions that could cause bodily harm or death.

A **Caution** identifies conditions and actions that could damage the Meter, the equipment under test, or cause permanent loss of data.

Warning

To prevent possible electrical shock or personal injury, follow these guidelines:

- Use this Meter only as specified in this manual or the protection provided by the Meter might be impaired.
- Do not use the Meter if it is damaged. Before you use the Meter, inspect the case. Look for cracks or missing plastic. Pay particular attention to the insulation surrounding the connectors.
- Make sure the battery door is closed and secured before operating the Meter.
- Replace the battery as soon as the battery indicator () appears.
- Remove test leads from the Meter before opening the battery door.
- Inspect the test leads for damaged insulation or exposed metal. Check the test leads for continuity. Replace damaged test leads before you use the Meter.
- Do not apply more than the rated voltage, as marked on the Meter, between the terminals or between any terminal and earth ground.
- Never operate the Meter with the cover removed or the case open.
- Use caution when working with voltages above 30 V ac rms, 42 V ac peak, or 60 V dc. These voltages pose a shock hazard.
- Use only the replacement fuses specified by the manual.
- Use the proper terminals, function, and range for measurements.
- Avoid working alone.
- When measuring current, turn off circuit power before connecting the Meter in the circuit. Remember to place the Meter in series with the circuit.

- **When making electrical connections, connect the common test lead before connecting the live test lead; when disconnecting, disconnect the live test lead before disconnecting the common test lead.**
- **Do not use the Meter if it operates abnormally. Protection may be impaired. When in doubt, have the Meter serviced.**
- **Do not use the Meter around explosive gas, vapor or in damp or wet environments.**
- **Use only three 1.5-V AA batteries, properly installed in the Meter case, to power the Meter.**
- **When servicing the Meter, use only specified replacement parts.**
- **When using probes, keep fingers behind the finger guards on the probes.**
- **Do not use the Low-Pass Filter to verify the presence of hazardous voltages. Voltages greater than what is indicated may be present. First, make a voltage measurement without the filter to detect the possible presence of hazardous voltage. Then add the filter.**

⚠ Caution

















To avoid possible damage to the Meter or to the equipment under test, follow these guidelines:

- **Disconnect circuit power and discharge all high-voltage capacitors before testing resistance, continuity, diodes, or capacitance.**
- **Use the proper terminals, function, and range for all measurements.**
- **Before measuring current, check the Meter's fuses. (See "Fuse Test".)**

Electrical Symbols

Table 1 lists the electrical symbols that appear in this document and on the Meter

Table 1. Symbols

	AC (Alternating Current)		Earth ground
	DC (Direct Current)		Fuse
	Hazardous voltage		Conforms to European Union directives.
	Risk of Danger. Important information. See Manual.		Conforms to relevant Canadian Standards Association directives.
	Battery. Low battery when displayed.		Double insulated
	Continuity test or continuity beeper tone.		Capacitance
CAT III	IEC Overvoltage Category III CAT III equipment is designed to protect against transients in equipment in fixed-equipment installations, such as distribution panels, feeders and short branch circuits, and lighting systems in large buildings.	CAT IV	IEC Overvoltage Category IV CAT IV equipment is designed to protect against transients from the primary supply level, such as an electricity meter or an overhead or underground utility service.
	Do not dispose of this product as unsorted municipal waste. Go to Fluke's website for recycling information.		Diode
	Inspected and licensed by TÜV Product Services.		Conforms to relevant Australian standards.

General Specifications

Maximum voltage between any terminal and earth ground	1000 V rms
△ Fuse for mA inputs	440 mA, 1000 V FAST Fuse
△ Fuse for A inputs	11 A, 1000 V FAST Fuse
Display	
Digital	6000 counts, updates 4/sec (Model 28 II also has 19,999 counts in high-resolution mode).
Bargraph	33 segments; updates 40/sec
Altitude	
Operating	2,000 meters
Storage	10,000 meters
Temperature	
Operating	-15 °C to +55 °C, to -40 °C for 20 minutes when taken from 20 °C
Storage	-55 °C to +85 °C (without battery) -55 °C to +60 °C (with battery)
Temperature coefficient	
28 II	0.05 X (specified accuracy) / °C (< 18 °C or > 28 °C)
27 II	0.1 X (specified accuracy) / °C (< 18 °C or > 28 °C)
Electromagnetic Compatibility (EN 61326-1:1997)	In an RF field of 3 V/M, accuracy = specified accuracy +20 counts, except 600 µA dc range total accuracy = specified accuracy +60 counts. Temperature not specified
Relative Humidity	0 % to 95 % (0 °C to 35 °C) 0 % to 70 % (35 °C to 55 °C)
Battery Type	3 AA Alkaline batteries, NEDA 15A IEC LR6
Battery Life	800 hrs typical without backlight (Alkaline)
Vibration	Per MIL-PRF-28800 for a Class 2 instrument
Shock	1 Meter drop per IEC 61010 (3 Meter drop with holster)
Size (H x W x L)	1.80 in x 3.95 in x 8.40 in (4.57 cm x 10.0 cm x 21.33 cm)
Size with Holster	2.50 in x 3.95 in x 7.80 in (6.35 cm x 10.0 cm x 19.81 cm)
Weight	1.14 lb (517.1 g)
Weight with Holster and Flex-Stand	1.54 lb (698.5 g)
Safety Compliance	Complies with ANSI/ISA S82.01-2004, CAN/CSA C22.2 61010-1-04 to 600 V Measurement Category IV. Licensed by TÜV to EN61010-1
Certifications	CSA, TÜV, CE,  (N10140), GOST
IP Rating	67 (Protected against dust and the effect of immersion between 15 cm and 1 m for 30 min)

Detailed Specifications

For all detailed specifications:

Accuracy is specified for 2 years after calibration, at operating temperatures of 18 °C to 28 °C, with relative humidity at 0 % to 95 %. Accuracy specifications take the form of \pm ([% of Reading] + [Number of least-significant digits]). For Model 28 II in the 4 ½-digit mode, multiply the number of least-significant digits (counts) by 10.

27 II AC Voltage

Range	Resolution	Accuracy ^[2]		
		40 Hz – 2 kHz	2 kHz – 10 kHz	10 kHz – 30 kHz
600.0 mV	0.1 mV	$\pm(0.5 \% + 3)$	$\pm(2 \% + 3)$	$\pm(4 \% + 10)$
6.000 V	0.001 V			
60.00 V	0.01 V			$\pm(4 \% + 10)$ ^[1]
600.0 V	0.1 V	$\pm(1.0 \% + 3)$	$\pm(3 \% + 3)$	Unspecified
1000 V	1 V			

[1] Specified to a maximum of 300 V ac
[2] Below 5 % of range, temperature coefficient is 0.15 X (specified accuracy) / °C (>40 °C).

28 II AC Voltage

AC conversions are ac-coupled and valid from 3 % to 100 % of range.

Range	Resolution	Accuracy					
		45 – 65 Hz	15 – 200 Hz	200 – 440 Hz	440 Hz – 1 kHz	1 – 5 kHz	5 – 20 kHz
600.0 mV	0.1 mV	$\pm(0.7\% + 4)$	$\pm(1.0\% + 4)^{[1]}$			$\pm(2\% + 4)$	$\pm(2\% + 20)^{[2]}$
6.000 V	0.001 V						
60.00 V	0.01 V					Unspecified	
600.0 V	0.1 V						
1000 V	1 V	$\pm(0.7\% + 2)$	Unspecified	Unspecified	Unspecified	Unspecified	
Low-Pass Filter			$\pm(1.0\% + 4)^{[1]}$	+1.0 % + 4 -6.0 % - 4 ^[4]	Unspecified	Unspecified	Unspecified

[1] Below 30 Hz, use smoothing function.
 [2] Below 10 % of range, add 12 counts.
 [3] Frequency range: 1 to 2.5 kHz
 [4] Specification increases from -1 % to -6 % at 440 Hz when filter is used.

DC Voltage, Conductance, and Resistance

Function	Range	Resolution	Accuracy
mV dc	600.0 mV	0.1 mV	$\pm(0.1\% + 1)$
V dc	6.000 V	0.001 V	$\pm(0.05\% + 1)$
	60.00 V	0.01 V	
	600.0 V	0.1 V	
	1000 V	1 V	
Ω	600.0 Ω	0.1 Ω	$\pm(0.2\% + 2)^{[2]}$
	6.000 k Ω	0.001 k Ω	$\pm(0.2\% + 1)$
	60.00 k Ω	0.01 k Ω	
	600.0 k Ω	0.1 k Ω	
	6.000 M Ω	0.001 M Ω	
	50.00 M Ω	0.01 M Ω	$\pm(1.0\% + 1)^{[1]}$
nS	60.00 nS	0.01 nS	$\pm(1.0\% + 10)^{[1,2]}$

[1] Add 0.5 % of reading when measuring above 30 M Ω in the 50 M Ω range, and 20 counts below 33 nS in the 60 nS range.
 [2] When using the rel function to compensate for offsets.

Temperature (28 II Only)

Range	Resolution	Accuracy ^[1, 2]
-200 °C to +1090 °C	0.1 °C	$\pm(1.0\% + 10)$
-328 °F to +1994 °F	0.1 °F	$\pm(1.0\% + 18)$

[1] Does not include error of the thermocouple probe.
 [2] Accuracy specification assumes ambient temperature stable to ± 1 °C. For ambient temperature changes of ± 5 °C, rated accuracy applies after 2 hour.

AC Current

Function	Range	Resolution	Burden Voltage	Accuracy	
				27 II ^[1, 2] (40 Hz – 1 kHz)	28 II ^[3] (45 Hz – 2 kHz)
μA ac	600.0 μA	0.1 μA	100 μV/μA	±(1.5 % + 2)	±(1.0 % + 2)
	6000 μA	1 μA	100 μV/μA		
mA ac	60.00 mA	0.01 mA	1.8 mV/mA		
	400.0 mA ^[4]	0.1 mA	1.8 mV/mA		
A ac	6.000 A	0.001 A	0.03 V/A		
	10.00 A ^[5,6]	0.01 A	0.03 V/A		

- [1] AC conversion for the 27 II is ac coupled and calibrated to the rms value of a sine wave input.
 [2] Below 300 counts, add 1 count and the temperature coefficient is 0.15 x (specified accuracy) / °C (>40 °C).
 [3] AC conversions for the 28 II are ac coupled, true rms responding, and valid from 3 % to 100 % of range, except 400 mA range. (5 % to 100 % of range) and 10 A range (15 % to 100 % of range).
 [4] 400 mA continuous. 600 mA for 18 hr maximum.
 [5] Δ 10 A continuous up to 35 °C. < 20 minutes on, 5 minutes off at 35 °C to 55 °C. >10 A to 20 A for 30 seconds maximum, 5 minutes off.
 [6] >10 A accuracy unspecified.

DC Current

Function	Range	Resolution	Burden Voltage	Accuracy	
				27 II	28 II
μA dc	600.0 μA	0.1 μA	100 μV/μA	±(0.2 % + 4)	±(0.2 % + 4)
	6000 μA	1 μA	100 μV/μA	±(0.2 % + 2)	±(0.2 % + 2)
mA dc	60.00 mA	0.01 mA	1.8 mV/mA	±(0.2 % + 4)	±(0.2 % + 4)
	400.0 mA ^[1]	0.1 mA	1.8 mV/mA	±(0.2 % + 2)	±(0.2 % + 2)
A dc	6.000 A	0.001 A	0.03 V/A	±(0.2 % + 4)	±(0.2 % + 4)
	10.00 A ^[2,3]	0.01 A	0.03 V/A	±(0.2 % + 2)	±(0.2 % + 2)

- [1] 400 mA continuous; 600 mA for 18 hr maximum.
 [2] Δ 10 A continuous up to 35 °C. < 20 minutes on, 5 minutes off at 35 °C to 55 °C. >10 A to 20 A for 30 seconds maximum, 5 minutes off.
 [3] >10 A accuracy unspecified.

Capacitance

Range	Resolution	Accuracy
10.00 nF	0.01 nF	±(1.0 % + 2) ^[1]
100.0 nF	0.1 nF	
1.000 μF	0.001 μF	±(1.0 % + 2)
10.00 μF	0.01 μF	
100.0 μF	0.1 μF	
9999 μF	1 μF	

- [1] With a film capacitor or better, using the rel mode to zero residual.

Diode

Range	Resolution	Accuracy
2.000 V	0.001 V	±(1.0 % + 1)

Frequency

Range	Resolution	Accuracy
199.99 Hz	0.01 Hz	±(0.005 % + 1) ^[1]
1999.9 Hz	0.1 Hz	
19.999 kHz	0.001 kHz	
199.99 kHz	0.01 kHz	
>200 kHz	0.1 kHz	

- [1] From 0.5 Hz to 200 kHz and for pulse widths > 2 μs.

Frequency Counter Sensitivity and Trigger Levels

Input Range	Minimum Sensitivity (RMS Sine Wave)		Approximate Trigger Level (DC Voltage Function)
	5 Hz – 20 kHz	0.5 Hz – 200 kHz	
600 mV dc	70 mV (to 400 Hz)	70 mV (to 400 Hz)	40 mV
600 mV ac	150 mV	150 mV	-
6 V	0.3 V	0.7 V	1.7 V
60 V	3 V	7 V (≤ 140 kHz)	4 V
600 V	30 V	70 V (≤ 14.0 kHz)	40 V
1000 V	100 V	200 V (≤ 1.4 kHz)	100 V

Duty Cycle (Vdc and mVdc)

Range	Accuracy
0.0 % to 99.9 % ^[1]	Within $\pm (0.2$ % per kHz + 0.1 %) for rise times < 1 μ s.
[1] 0.5 Hz to 200 kHz, pulse width >2 μ s. Pulse width range is determined by the frequency by the frequency of the signal.	

Input Characteristics

Function	Overload Protection	Input Impedance (nominal)	Common Mode Rejection Ratio (1 k Ω unbalance)	Normal Mode Rejection						
\bar{V}	1000 V rms	10 M Ω <100 pF	> 120 dB at dc, 50 Hz or 60 Hz	> 60 dB at 50 Hz or 60 Hz						
$m\bar{V}$	1000 V rms		> 120 dB at dc, 50 Hz or 60 Hz	> 60 dB at 50 Hz or 60 Hz						
\tilde{V}	1000 V rms	10 M Ω < 100 pF (ac-coupled)	> 60 dB, dc to 60 Hz							
		Open Circuit Test Voltage	Full Scale Voltage		Typical Short Circuit Current					
			To 6 M Ω	5 M Ω or 60 nS	600 Ω	6 k Ω	60 k Ω	600 k Ω	6 M Ω	50 M Ω
Ω	1000 V rms	<2.8 V dc	<850 mV dc	<1.3 V dc	500 μ A	100 μ A	10 μ A	1 μ A	0.2 μ A	0.1 μ A
\rightarrow	1000 V rms	<2.8 V dc	2.200 V dc		1.0 mA typical					

MIN MAX Recording

Nominal Response	Accuracy	
	27 II	28 II
100 ms to 80 %	Specified accuracy ± 12 counts for changes >200 ms in duration (± 40 counts in ac with beeper on)	
100 ms to 80 % (dc functions)		Specified accuracy ± 12 counts for changes >200 ms in duration
120 ms to 80 % (ac functions)		Specified accuracy ± 40 counts for changes >350 ms and inputs >25 % of range
250 μ s (peak) ^[1]		Specified accuracy ± 100 counts for changes >250 μ s in duration (add ± 100 counts for readings over 6000 counts) (add ± 100 counts for readings in Low Pass mode)
[1] For repetitive peaks: 1 ms for single events.		

Basic Maintenance

⚠️⚠️ Warning

To avoid possible electric shock or personal injury, repairs or servicing covered in this manual should be performed only by qualified personnel.

General Maintenance

Periodically wipe the case with a damp cloth and mild detergent. Do not use abrasives or solvents.

Dirt or moisture in the terminals can affect readings and can falsely activate the Input Alert feature. Clean the terminals as follows:

1. Turn the Meter off and remove all test leads.
2. Shake out any dirt that may be in the terminals.
3. Soak a clean swab with mild detergent and water. Work the swab around in each terminal. Dry each terminal using canned air to force the water and detergent out of the terminals.

⚠️⚠️ Warning

To avoid electrical shock or personal injury, remove the test leads and any input signals before replacing the battery or fuses. To prevent damage or injury, install **ONLY** specified replacement fuses with the amperage, voltage, and speed ratings shown in Table 7.

Fuse Test

As shown in Figure 1, with the Meter in the Ω function, insert a test lead into the Ω jack and place the probe tip on the other end of the test lead against the metal of the current input jack. If “LEAD” appears in the display, the probe tip has been inserted too far into the amps input jack. Back the lead out a bit until the message disappears and either OL or a resistance reading appears in the display. The resistance value should be as shown in Figure 1. If the tests give readings other than those shown, have the Meter serviced.

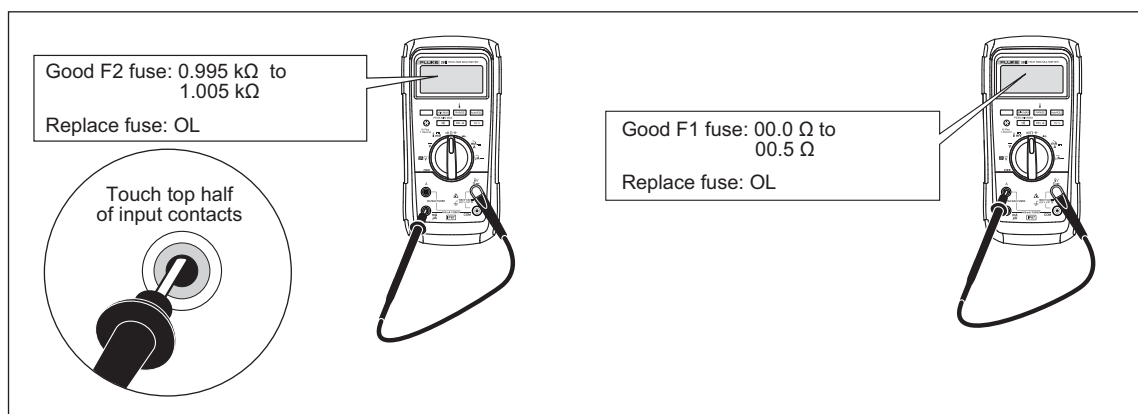

Figure 1. Current Fuse Test

gaq105.eps

How to Replace the Batteries

⚠ ⚠ Warning

To avoid false readings, which could lead to possible electric shock or personal injury, replace the battery as soon as the battery indicator (⚡) appears. If the display shows “batt” the Meter will not function until the battery is replaced.

Replace the battery as follows, refer to Figure 2:

1. Turn the rotary switch to OFF and remove the test leads from the terminals.
2. Remove the six Phillips-head screws from the case bottom and remove the battery door (①).

Note

While lifting the battery door, ensure the rubber gasket stays attached to the battery compartment barrier.

3. Remove the three batteries and replace all three with AA Alkaline batteries (②).
4. Ensure the battery compartment gasket (③) is properly installed around the outside edge of the battery compartment barrier.
5. Replace the battery door by aligning the battery compartment barrier with battery compartment.
6. Secure the door with the six Phillips-head screws.

How to Replace the Fuses

Referring to Figure 2, examine or replace the Meter's fuses as follows:

1. Turn the rotary switch to OFF and remove the test leads from the terminals.
2. Refer to step 2 under the How to Replace the Batteries section above to remove the battery door.
3. Remove the fuse compartment seal (④) from the fuse compartment.
4. Gently lift out the fuse compartment door (⑤) from the fuse compartment.
5. Remove the fuse by gently prying one end loose, then sliding the fuse out of its bracket (⑥).
6. Install ONLY specified replacement fuses with the amperage, voltage, and speed ratings shown in Table 7. The 440-mA fuse is shorter than the 10-A fuse. For correct placement of each fuse, note the marking on the printed circuit board under each fuse.
7. Replace the fuse compartment door by aligning the arrow on the fuse door with the arrow on the case bottom and lowering the door into the fuse compartment.
8. Replace the fuse compartment seal by aligning the tab on the seal with the outline on the case bottom. Ensure the seal (④) is properly seated.
9. Refer to steps four through six under the Replacing the Batteries section above to reinstall the battery door.

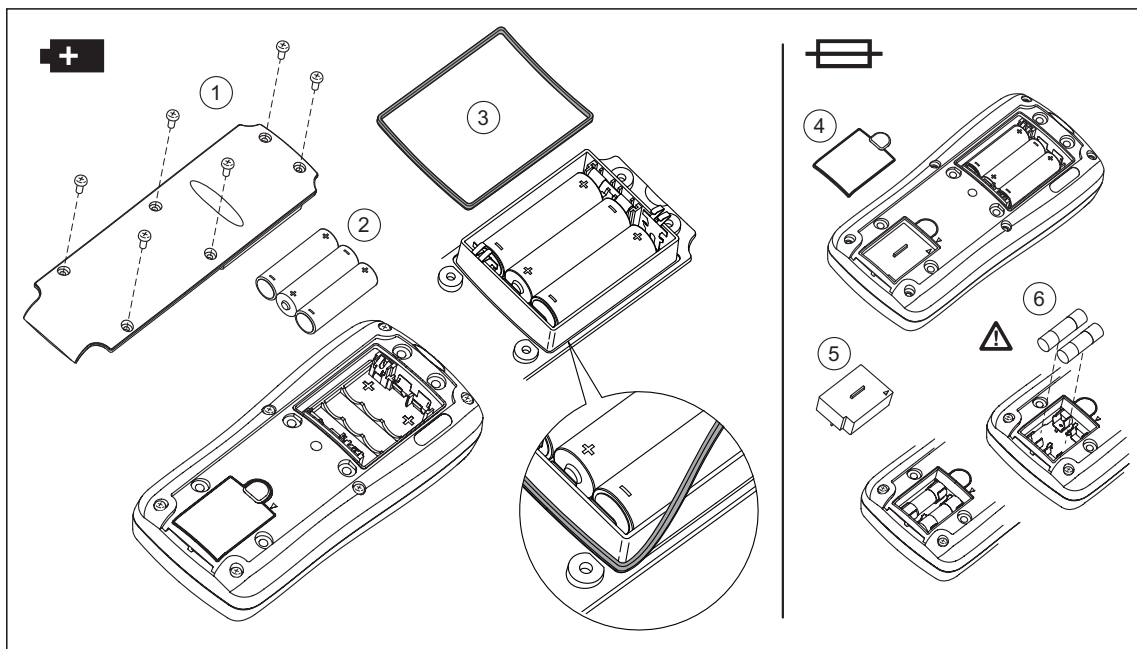

Figure 2. Battery and Fuse Replacement

gaq10.eps

Performance Tests

⚠️⚠️ Warning

To avoid electric shock, do not perform the performance test procedures unless the Meter is fully assembled.

The following performance tests verify the complete operation of the Meter and check the accuracy of each Meter function against its specifications. Performance tests should be performed bi-annually to ensure that the Meter is within accuracy specifications. If the Meter fails any part of the test, calibration adjustment and/or repair is indicated.

In the performance tests, the Meter is referred to as the unit under test (UUT).

Required Equipment

Table 2 lists the equipment required to conduct a performance test on the Meter.

Table 2. Required Equipment

Recommended Equipment	Measurement Function	Accuracy
5520A Multi-product Calibrator (or equivalent)	DC Volts	0 to 1000 V ±0.012 %
	DC Current	350 μ A to 2 A ±0.05 %
	AC Volts	0 to 1000 V ±0.15 % @ 60 Hz to 20 kHz ±3 %
	AC Current	350 μ A to 2 A ±0.39 % @ 60 Hz to 1 kHz
	Resistance	1 Ω to 100 M Ω ±0.06 %
	Capacitance	9 to 900 μ F ±0.475 %
	Frequency	19.999 to 199.99 kHz, ±0.0137 % 150 mV to 6 Vrms, ±5 %
K-type Thermocouple, mini-plug on both ends	Temperature	

Testing Meter Accuracy

To test the accuracy of the Meter, perform the steps in Table 3.

Table 3. Accuracy Tests





Step	Test Function	Range	5520A Output	Display Reading	
				27 II	28 II
1	 AC Volts	600 mV	60 mV, 60 Hz	59.4 to 60.6	59.2 to 60.8
2		600 mV	330 mV, 60 Hz	328.0 to 332.0	327.3 to 332.7
3		600 mV	600 mV, 13 kHz	575.0 to 625.0	586.0 to 614.0
4		6 V	675 mV, 60 Hz	0.669 to 0.681	0.666 to 0.684
5		6 V	3.3 V, 60 Hz	3.280 to 3.320	3.273 to 3.327
6		6 V	3.3 V, 20 kHz	3.158 to 3.442	3.214 to 3.386
7		60 V	6.75 v, 60 Hz	6.69 to 6.81	6.68 to 6.82
8		60 V	33 V, 60 Hz	32.80 to 33.20	32.75 to 33.25
9		60 V	33 V, 20 kHz	31.58 to 34.42	N/A
10		60 V	33 V, 5 kHz	32.30 to 33.7	N/A
11		600 V	67.5 V, 60 Hz	66.9 to 68.1	66.8 to 68.2
12		600 V	330 V, 60 Hz	328.0 to 332.0	327.5 to 332.5
13		600 V	330 V, 2.5 kHz	323.1 to 336.9	323.0 to 337.0
14		1000 V	100 V, 60 Hz	96 to 104	97 to 103
15		1000 V	1000 V, 1 kHz	987 to 1013	986 to 1014
16	 AC Volts Frequency	600 mV	150 mV, 99.95 kHz	99.93 to 99.97	99.93 to 99.97
17		600 mV	150 mV, 199.50 kHz	199.48 to 199.52	199.48 to 199.52
18	Sensitivity	6 V	0.7 V, 99.95 kHz	99.93 to 99.97	99.93 to 99.97
19		60 V	7 V, 99.95 kHz	99.93 to 99.97	99.93 to 99.97
20	 Trigger level	6 V	3.4 V, 1 kHz Sq. Wave	999.8 to 1000.2	999.8 to 1000.2
21	 Duty Cycle	6 V	5 V, 1 kHz, DC offset 2.5 V Sq. Wave	49.7% to 50.3 %	49.7 % to 50.3 %
22	 DC Volts	6 V	3.3 V dc	3.297 to 3.303	3.297 to 3.303
23		60 V	33 V dc	32.97 to 33.03	32.97 to 33.03
24		600 V	330 V dc	329.7 to 330.3	329.7 to 330.3
25		1000 V	1000 V dc	998 to 1002	998 to 1002

Table 3. Accuracy Tests (cont.)

Step	Test Function	Range	5520A Output	Display Reading	
				27 II	28 II
26	$\overline{\text{mV}}$	600 mV	50 mV dc	49.8 to 50.2	49.8 to 50.2
27	DC Volts	600 mV	330 mV dc	329.6 to 330.4	329.6 to 330.4
28	Ω Ohms	600 Ω	330 Ω (Use 2 wire Comp)	329.1 to 330.9	329.1 to 330.9
29		6 k Ω	3.3 k Ω (Use 2 wire Comp)	3.292 to 3.308	3.292 to 3.308
30		60 k Ω	33 k Ω	32.92 to 33.08	32.92 to 33.08
31		600 k Ω	330 k Ω	329.2 to 330.8	329.2 to 330.8
32		6 M Ω	3.3 M Ω	3.292 to 3.308	3.292 to 3.308
33		50 M Ω	30 M Ω	29.69 to 30.31	29.69 to 30.31
34	nS Conductance	60 nS	100 M Ω	9.60 to 10.40	9.60 to 10.40
35	$\rightarrow $ Diode	6 V	2.0 V dc	1.979 to 2.021	1.979 to 2.021
36	$\overline{\text{mA}}$ AC Amps	6 A	3.0 A, 60 Hz	2.953 to 3.047	2.968 to 3.032
37	$\overline{\text{mA}}$ DC Amps	6 A	3.0 A	2.990 to 3.010	2.990 to 3.010
38	$\overline{\text{mA}}$ AC Milliamps	60 mA	33 mA, 60 Hz	32.48 to 33.52	32.65 to 33.35
39		400 mA	330 mA, 60 Hz	324.8 to 335.2	326.5 to 333.5
40	$\overline{\text{mA}}$ DC Milliamp	60 mA	33 mA	32.89 to 33.11	32.89 to 33.11
41		400 mA	330 mA	329.1 to 330.9	329.1 to 330.9
42	$\overline{\mu\text{A}}$ AC Microamps	600 μA	330 μA , 60 Hz	324.8 to 335.2	326.5 to 333.5
43		6000 μA	3300 μA , 60 Hz	3248 to 3352	3265 to 3335
44	$\overline{\mu\text{A}}$ DC Microamps	600 μA	330 μA	328.9 to 331.1	328.9 to 331.1
45		6000 μA	3300 μA	3291 to 3309	3291 to 3309
46	\dashv	10 nf	Open input ¹	0.28 to 0.48	0.28 to 0.48
47	Capacitance	100 nf	5 nf ²	4.7 to 5.3	4.7 to 5.3
48		100 μf	9.5 μf	9.2 to 9.8	9.2 to 9.8
49	$\overline{\text{V}}$	1000 V	400 V, 400 Hz	N/A	372 to 408
50	Low Pass Filter - 28 II	1000 V	400 V, 800 Hz ³	N/A	226 to 340
51	VDC Peak Min/Max – 28 II	6 V	8 Vpp, 2 kHz Sq. Wave, DC offset 2 V	N/A	Min = -1.898 to - 2.102 Max = 5.896 to 6.104

Table 3. Accuracy Tests (cont.)

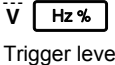
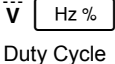
Step	Test Function	Range	5520A Output	Display Reading	
				27 II	28 II
52	mVdc Temperature ⁴ – 28 II		0 °C	N/A	-1.0 to 1.0
53			100 °C	N/A	98.0 to 102.0
54	Backlight		Press backlight button	Backlight comes on	Backlight comes on
55			Press backlight button	Backlight intensifies	Backlight intensifies
56			Press backlight button	Backlight goes off	Backlight goes off

[1] Remove test leads from unit.
 [2] Use REL to compensate for internal Meter and lead capacitance (must disconnect test leads from calibrator before pushing REL)
 [3] The Meter accuracy is not specified at this input signal frequency with Low-pass filter selected. The display reading shown, checks that the Low-pass filter is active and follows an expected roll-off curve.
 [4] To ensure accurate measurement, the Meter and thermocouple adapter must be at the same temperature. After connecting the thermocouple adapter to the Meter allow for reading to stabilize before recording display reading.

Calibration Adjustments

Perform the Calibration Adjustment Procedure if the Meter fails any performance tests. If the adjustment routine is discontinued prior to completion, no changes are made to the calibration constants that are stored in memory. The following is an explanation of the pushbutton features and requirements to enter the CAL mode.

Cal Mode Pushbutton Functions

- The CAL mode will be initiated by holding down the MINMAX pushbutton at power up and entering a four digit password.
- The AutoHOLD pushbutton will act as an "ENTER" key and will advance through the CAL initiation and adjustment procedure steps.
- The pushbuttons are used to select a four-digit password.

During initiation of the CAL mode, a display count will show how many times calibration constants have been written to memory.

Entering and Displaying the Four-Digit Password

When the Meter was manufactured it was given a default password of 1234. The following pushbuttons are used to select the password. Each pushbutton represents the indicated digit.

Yellow = 1 MINMAX = 2 RANGE = 3 AutoHOLD = 4
 Backlight = 5 Continuity = 6 REL = 7 Hz = 8

After selecting the password the user has two choices:

Pressing AutoHOLD will display "[-0]" which indicates correct password and successful entry. You may now proceed with the first calibration step.

Pressing RANGE will display "- - - -", which indicates correct password, proceed to select a new password.

If the password is incorrect, the concluding AutoHOLD or RANGE pushbutton press will instead cause the Meter to double beep and the display will show "????". The password entry process was unsuccessful and can be tried again or you may exit this mode by turning the Meter off.

Changing the Password

To change the password in the Meter:

1. Turn the Meter Rotary Switch from OFF to VAC mode while holding down the MINMAX pushbutton at the same time. The Meter will display ζ RL.
2. Press the AutoHOLD pushbutton twice. The display should show "????"
3. Using the pushbuttons select the old password (do not use AutoHOLD to save the password)
4. Press the RANGE pushbutton. The Meter should display " _ _ _ _ " .
5. Use the pushbuttons to select a desired new password.
6. Press AutoHOLD to save the new password.

Restoring the Default Password

If the password has been forgotten, the default password (1234) can be restored by performing the following:

1. Turn the rotary switch of the Meter to **OFF**.
2. Remove the bottom case and bottom shield of the Meter.
3. Check the revision number on the PCB. Board revision location is identified in Figures 3 and 4 below.

If the revision number is 010:

4. Remove the PCB from the top case.
5. Apply power to the PCB by clipping on a dc voltage between 3.5 V and 5 V at the test points marked “+” and “-” at the edge of the board. See Figure 3.

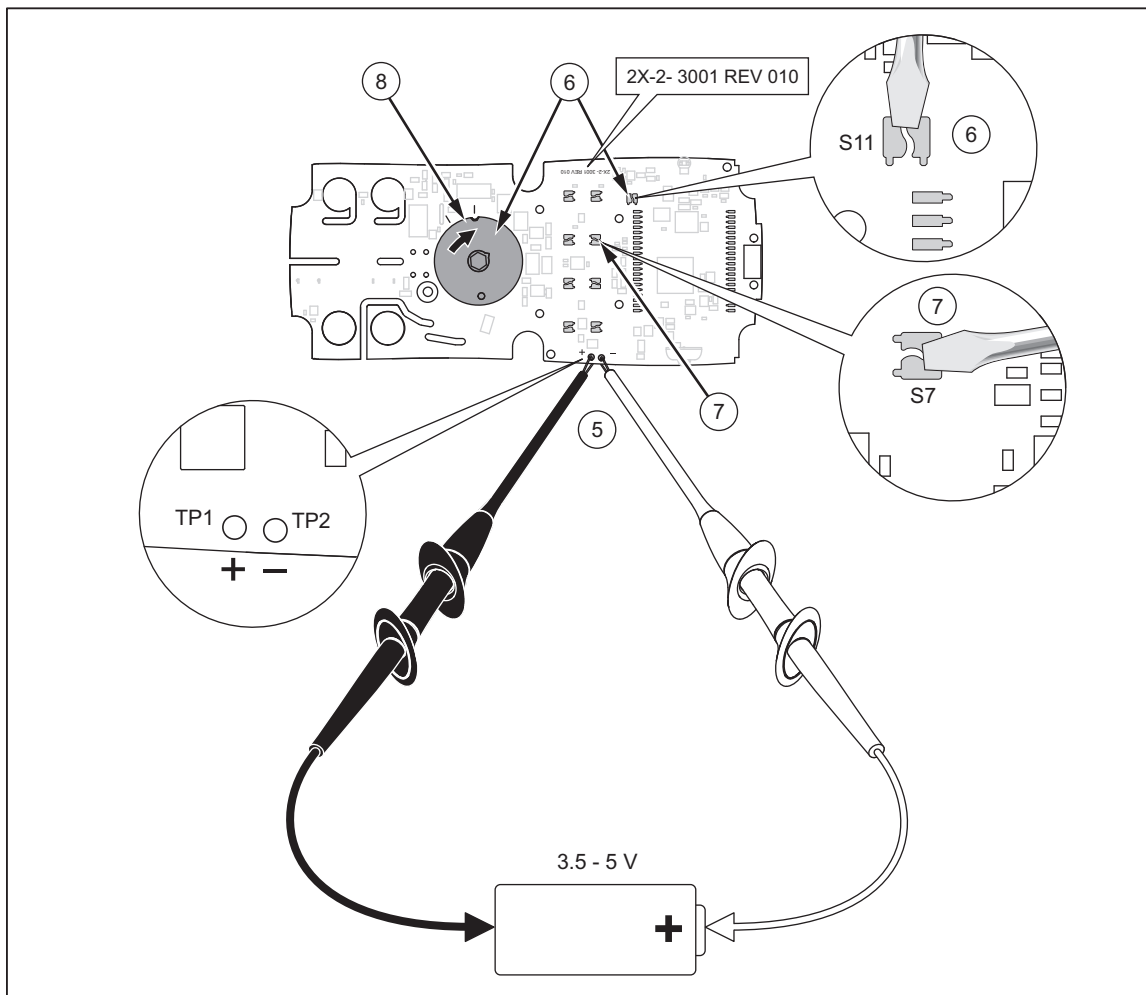

Figure 3. Revision 010 Board Layout

gaq101.eps

6. While shorting across keypad button S7, turn the rotary switch one position clockwise. See Figure 3.
7. Short across keypad button S11. See Figure 3.
8. Turn the rotary switch one position counterclockwise, back to its original position.
9. The default password is now restored.
10. Reassemble the Meter before performing adjustments or testing.

If the revision number is 011 or higher:

4. Apply power to the PCB by clipping on a dc voltage between 3.5 V and 5 V at the test points marked “+” and “-” at the edge of the board. See Figure 4.

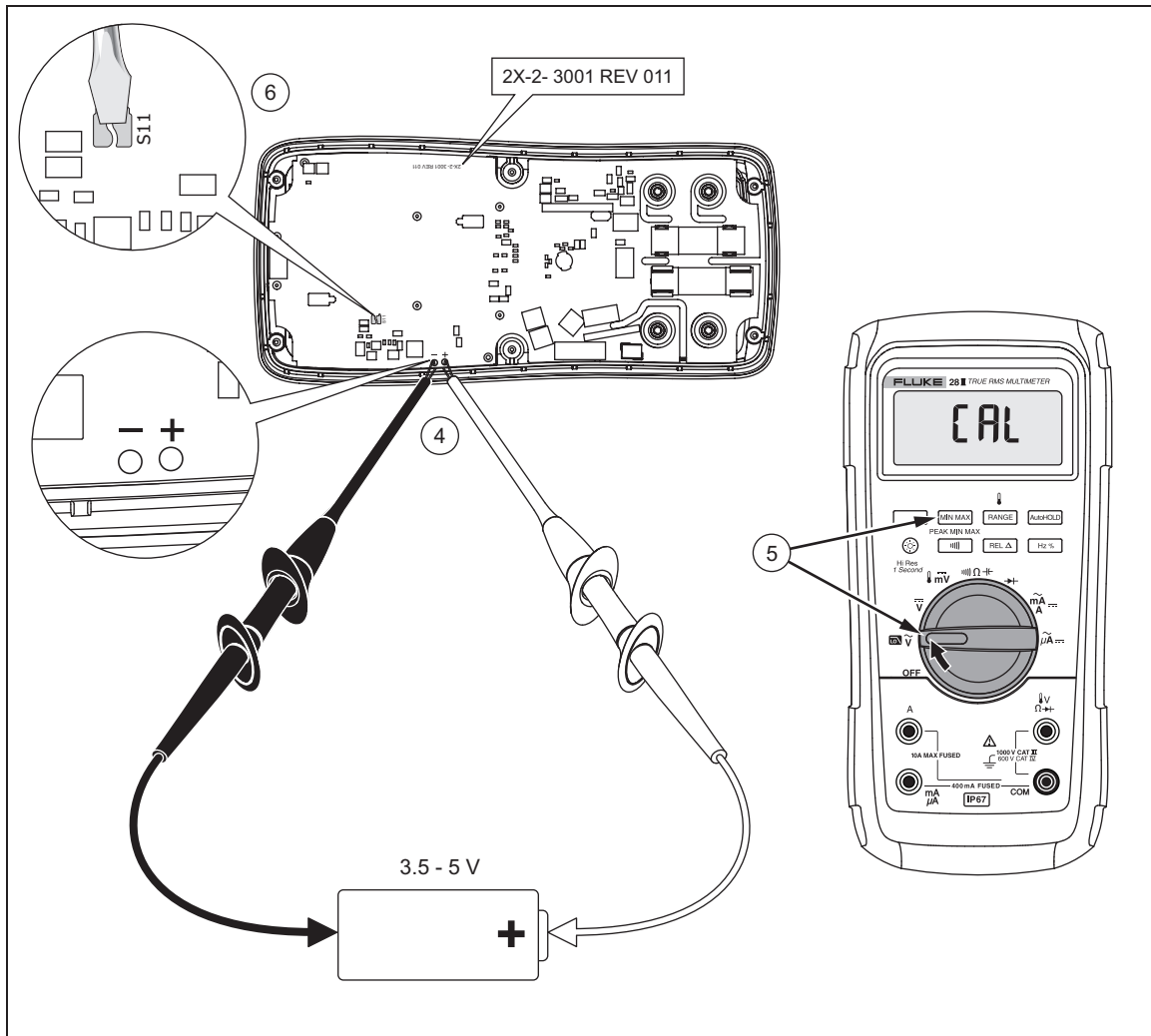

Figure 4. Revision 011 Board Layout





gaq102.eps

5. Turn the rotary switch from **OFF** to \tilde{V} while holding down MIN MAX at the same time. The Meter should display CAL.
6. Short across keypad button S11 on the back of the PCB. See Figure 4. The Meter should beep.
7. Turn the rotary switch one position counterclockwise, back to the OFF position.
8. The default password is now restored.
9. Reassemble the Meter before performing adjustments or testing.

Other Pushbutton Functions



Table 4 list the button on the Meter and describes what the button does when pressed after the password has been entered and **AutoHOLD** pressed.

Table 4. Pushbutton Functions During Cal Mode

Button	Cal Mode Description
 (yellow)	Press and hold to test the present function. The measurement is not calibrated so it may be inaccurate. This is normal.
	Press and hold to display the required input level.
	Press and hold to display the frequency of the input signal.
	Press to store the new calibration adjustment value and advance to the next step. This pushbutton is also used to exit calibration adjustment mode after the calibration adjustment sequence is complete.

Calibration Adjustment Procedure

In the following procedure, some adjustment steps take longer to execute than others (10 to 15 Seconds). For some of these steps the Meter gives a double beep to indicate completion. Not all steps have this feature.

1. Turn the rotary switch of the Meter from **OFF** to  while holding down **MIN MAX** at the same time. The Meter should display .
2. Press **AutoHOLD** once to see the number of calibrations that have been completed. Press **AutoHOLD** again to enable password entry. The Meter should display "????".
3. Use the keypad pushbuttons to enter the existing password and press **AutoHOLD**. The Meter should display .
4. Apply the value listed in Table 5 or 6 for each calibration step, and/or (optional) press the **MIN MAX** to display the required input signal level and press **Hz %** to display the required input signal frequency.

Note

*After pressing **AutoHOLD**, wait until the step number advances before changing the calibrator source or turning the rotary switch of the Meter. If the reference source input is not within an anticipated range of the required value, the Meter will emit a double beep and not allow completion of the step. Set the calibrator to standby prior to changing the function switch position and or after completing adjustment of each function. If the calibration adjustment is not completed correctly, the Meter will not operate correctly.*

Table 5. Fluke 27 II Calibration Adjustment Steps

Function (Switch Position)	Adjustment Step	Input Value
\tilde{V} (AC Volts)	C-01	0 mV, 0 Hz
	C-02	6.0 mV, 60 Hz
	C-03	60.0 mV, 60 Hz
	C-04	600.0 mV, 60 Hz
	C-05	600.0 mV, 20 kHz
	C-06	6.0 V, 60 Hz
	C-07	6.0 V, 20 kHz
	C-08	60.0 V, 60 Hz
	C-09	60.0 V, 20 kHz
	C-10	600.0 V, 60 Hz
	C-11	600.0 V, 10 kHz
\overline{V} (DC Volts)	C-12	6.0 V
	C-13	60.0 V
	C-14	600.0 V
$\downarrow \overline{mV}$ (DC Millivolts)	C-15	600.0 mV
	C-16	60.00 mV
Ω (Ohms)	C-17	600.0 Ω
	C-18	6.000 k Ω
	C-19	60.00 k Ω
	C-20	600.0 k Ω
	C-21	6.000 M Ω
	C-22	0.000 Ω
	C-23	50.0 M Ω
$\rightarrow \dashv$ (Diode Test)	C-24	3.000 V
$\frac{mA}{A}$ (Amps)	C-25	0.000 A, 0 Hz
	C-26	60.0 mA 60 Hz
	C-27	6.0 A, 60 Hz
	C-28	6.0 A, 0 Hz
$\frac{mA}{A}$ (Milliamps)	C-29	0.0 mA, 0 Hz
	C-30	600.0 μ A, 60 Hz
	C-31	6.0 mA, 60 Hz
	C-32	60.0 mA, 60 Hz
	C-33	400.0 mA, 60 Hz
	C-34	60.0 mA, 0 Hz
	C-35	400.0 mA, 0 Hz

Table 5. Fluke 27 II Calibration Adjustment Steps (cont.)

Function (Switch Position)	Adjustment Step	Input Value
$\mu\tilde{A}$ (Microamps)	C-36	0.0 μ A ac, 0 Hz
	C-37	30.0 μ A, 60 Hz
	C-38	60.0 μ A, 60 Hz
	C-39	600.0 μ A, 60 Hz
	C-40	6000.0 μ A, 60 Hz
	C-41	600.0 μ A, 0 Hz
	C-42	6000.0 μ A, 0 Hz

Table 6. Fluke 28 II Calibration Adjustment Steps



Function (Switch Position)	Adjustment Step	Input Value
 (AC Volts)	C-01	600.0 mV, 60 Hz
	C-02	600.0 mV, 20 kHz
	C-03	6.000 V, 60 Hz
	C-04	6.000 V, 20 kHz
	C-05	60.00 V, 60 Hz
	C-06	60.00 V, 20 kHz
	C-07	600.0 V, 60 Hz
	C-08	600.0 V, 10 kHz
\bar{V} (DC Volts)	C-09	6.000 V
	C-10	60.00 V
	C-11	600.0 V
 (DC Millivolts)	C-12	600.0 mV
	C-13	60.00 mV
Ω (Ohms)	C-14	600.0 Ω
	C-15	6.000 k Ω
	C-16	60.00 k Ω
	C-17	600.0 k Ω
	C-18	6.000 M Ω
	C-19	0.000 Ω
	C-20	50.0 M Ω
 (Diode Test)	C-21	3.000 V
\tilde{A} (Amps)	C-22	6.000 A, 60 Hz
	C-23	6.000 A dc
\tilde{A} (Amps)	C-24	60.00 mA, 60 Hz
	C-25	400.0 mA, 60 Hz
	C-26	60.00 mA dc
	C-27	400.0 mA dc

Table 6. Fluke 28 II Calibration Adjustment Steps (cont.)

Function (Switch Position)	Adjustment Step	Input Value
$\mu\tilde{A}$ (Microamps)	C-28	600.0 μ A, 60 Hz
	C-29	6000 μ A, 60 Hz
	C-30	600.0 μ A dc
	C-31	6000 μ A dc

Disassembling the Meter

To disassemble the Meter:

1. Use a Philips screwdriver to remove the six battery-door screws (H1).
2. Lift up the battery door (MP1) at the top end of the Meter and remove it from the case back.
3. Remove three AA batteries.
4. Remove the fuse access door (MP4).
5. Remove the fuse cap (MP5).
6. Use a Philips screwdriver to remove the bottom-case screws (H2) with their O-rings (H3).
7. Separate the bottom case (MP6) from the top case (MP19).
8. Use a Philips screwdriver to remove the bottom-shield screw (H4).
9. Remove the bottom shield (MP9) from the Meter.
10. Use a Philips screwdriver to remove four PCA input screws (H5).
11. Use a Philips screwdriver to remove six PCA screws (H4) from the board.
12. Remove the PCA from the top case.
13. Remove the top shield (MP13) from the top case.
14. Remove the elastomerics (MP10) from the top shield.
15. Unsnap mask (MP15) from the top shield (MP13).
16. Remove the LCD (DS1) from the top shield.
17. Remove the backlight (MP14) from the top shield.
18. Remove the keypad (MP18) from the top case.
19. Remove the RSOB spacer (MP16) from the top case.
20. Remove the E-clip holding the spring detent (MP17) from the top case.
21. Remove the spring detent from the top case.
22. Remove the knob (MP20) from the top case.

Reassembling the Meter

Note

Before reassembling the Meter, read the How to Retain the IP67 Rating section first.

To reassemble the Meter, perform the disassembly steps in reverse order.

How to Retain the IP67 Rating

The following items identify parts of the Meter that can compromise the IP67 rating by leaking if assembly instructions are not followed carefully.

1. Knob: The knob has an overmolded seal that fits tight against the top case. This area must be lubed and the lube must be spread evenly around the seal area.
2. E-clip: Make sure it is installed correctly.
3. Keypad: The keypad must be seated correctly and all six board screws tightened to 6 in-lbs torque.
4. Bottom case gasket: The gasket must be installed so that the gasket does not have any twists, bends, waves, etc. The gasket must be completely flat in the bottom case groove. This can be accomplished by using a modified top case to push the gasket into position.
5. Battery door gasket: Place over battery compartment walls and push each corner down as far as they will go. Install battery door screws with 6 in-lbs torque.
6. Fuse access door: Place onto bottom case and wiggle it to make sure it is fully seated. Install the battery door screws with 6 in-lbs torque.
7. Case screw o-ring: Torque case screws to 12 in-lbs torque. Verify that the o-rings are not sticking out of the sides of the screw head.

Note

If you want to ensure your Meter meets the IP67 rating, return the Meter to a qualified Fluke Service center.

Replacement Parts

Table 7 lists the Meter's replaceable parts identified in Figure 5.

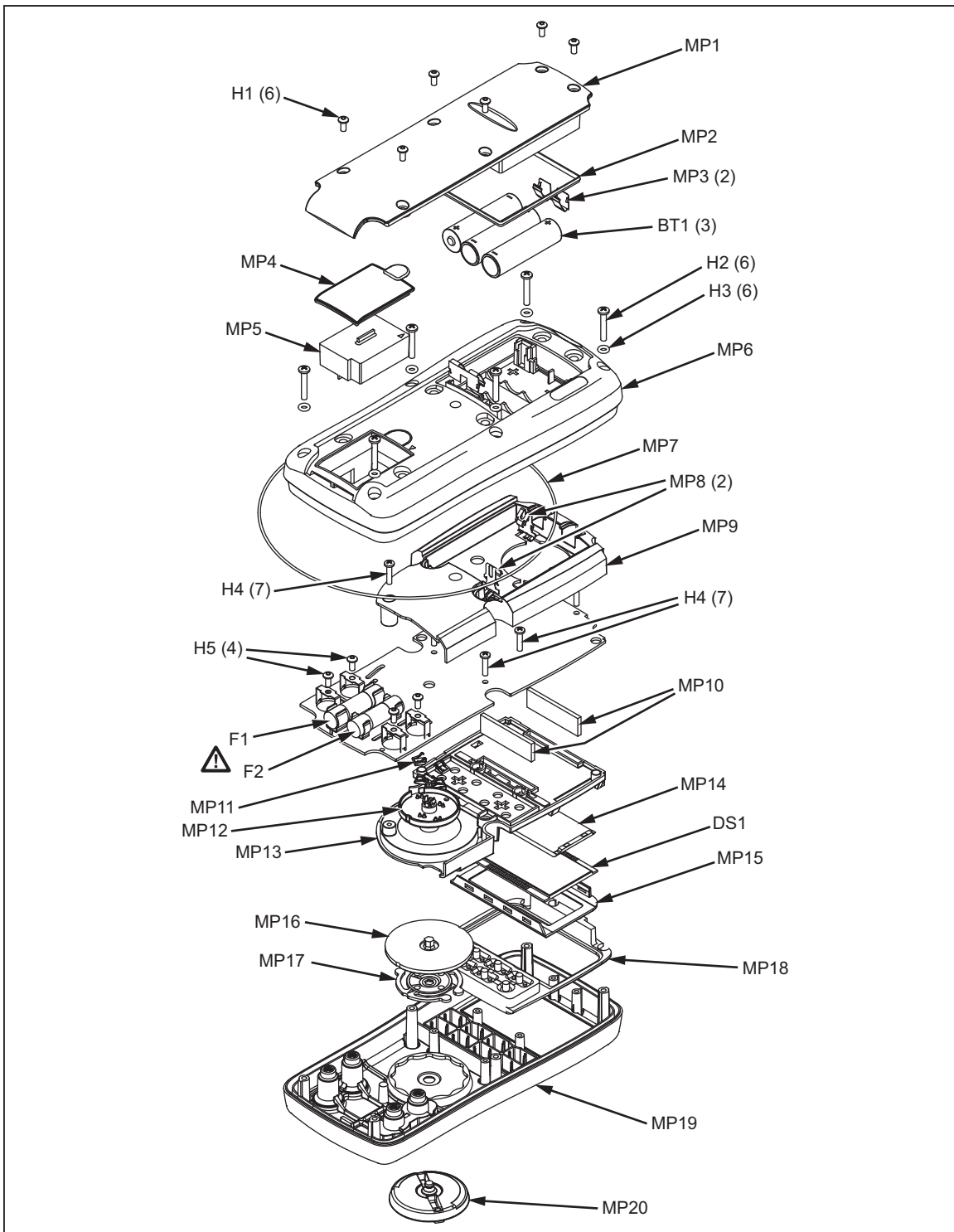

Figure 5. Exploded View of Meter

gaq106.eps

Table 7. Replaceable Parts List

Item	Description	Part Number	Qty.
BT1	BATTERY,PRIMARY,ZN-MNO2,1.5V,2.24AH,15A,LR6,ALKALINE,AA,14X50MM,BULK	376756	3
DS1	LCD,4.5 DIGIT,TN,TRANSFLECTIVE,BAR GRAPH,OSPR80,,FLUKE-87-5	2065213	1
F1	△FUSE,11A,1000V,FAST.406INX1.5IN,BULK	803293	1
F2	△FUSE,.440 A,1000V,FAST.406INX1.5IN,BULK	943121	1
H1	SCREW,M3X0.5,6MM,PAN,PHILLIPS,STEEL,ZINC-BLACK CHROMATE	2032792	6
H2	SCREW,5-14,.750,PAN,HEXALOBULAR,STEEL,ZINC-BLK CHROMATE,BLUNT PT,THREAD FORM	1558745	6
H3	O-RING,NITRILE,INT LUBE,SHORE A 70,AS 568A-006,.114 ID,.070 W	705947	6
H4	SCREW,4-14,.510,PAN,PHILLIPS,STEEL,ZINC-CHROMATE,THREAD CUT	853668	7
H5	SCREW,M3X0.5,6MM,PAN,PHILLIPS,STEEL,ZINC-CHROMATE	2743764	4
MP1	FLUKE-2X-2-2010,BATTERY DOOR, WITHOUT BATTERY CONTACTS	3321030	1
MP2	FLUKE-2X-II-8007,GASKET, BATT DOOR, FLUKE 27-II AVG AND FLUKE 28-II TRMS METERS	3439087	1
MP3	FLUKE 89-4-8012 ,BATTERY CONTACT, DUAL	666435	2
MP4	FLUKE-2X-2-2014,FUSE ACCESS DOOR, 27-2 AVG AND 28-2 TRMS MULTIMETER	3400480	1
MP5	FLUKE-2X-2-2015,FUSE CAP	3440546	1
MP6	FLUKE-2X-2-2004,CASE, BOTTOM WITHOUT BATTERY CONTACTS	3320869	1
MP7	FLUKE 2X-II-8006,GASKET, TOP CASE, FLUKE-27-II AVG AND FLUKE-28-II TRMS METERS	3439079	1
MP8	SHENGUANG-8012,BATTERY CONTACT SHENGUANG	3324731	2
MP9	FLUKE-2X-2-8002,BOTTOM SHIELD, FLUKE 27-2 AVG / FLUKE 28-2 TRMS MULTIMETER	3371942	1
MP10	CONNECTOR,ELASTOMERIC,.375 HIGH,.10 THICK,1.59 LONG,BULK	3440661	2
MP11	FLUKE-17X-8001,CONTACT, RSOB	3084560	4
MP12	FLUKE 87-5-2009,HOUSING, RSOB	2073945	1
MP13	FLUKE-2X-2-8001,TOP SHIELD, FLUKE 27-2 AVG / FLUKE 28-2 TRMS MULTIMETER	3371939	1
MP14	FLUKE-2X-2-8009,BACKLIGHT, FLUKE 27II / FLUKE 28II MULTIMETER	3471251	1

Table 7. Replaceable Parts List (cont.)

Item	Description	Part Number	Qty.
MP15	FLUKE-27-2-2501-04,MASK, LCD (PAD XFER), (for 27-2)	3400020	1
	FLUKE-28-2-2501-05,MASK, LCD (PAD XFER) (for 28-2)	3400047	1
MP16	FLUKE-2X-2-2007,SPACER, RSOB	3320891	1
MP17	FLUKE-2X-2-2008,DETENT, SPRING	3320905	1
MP18	FLUKE-2X-8003,KEYPAD, FLUKE 27-2 AND FLUKE 28-2	3359962	1
MP19	FLUKE-27-2-2501, TOP CASE, PAD XFER (For 27-2)	3441368	1
	FLUKE-28-2-2502, TOP CASE, PAD XFER (for 28-2)	3320857	1
MP20	FLUKE-2X-2-2009,ROTARY KNOB	3320922	1
Not Shown	FLUKE-2X-2-2011,HOLSTER w/Tilt Stand	3321048	1
Not Shown	TL75-4201 ,TEST LEADS	855742	1
Not Shown	80BK-A-8001, TYPE K THERMOCOUPLE ASSEMBLY (for 28-2)	2747900	1
Not Shown	FLUKE 87-5-8009,TILTSTAND	2074040	1
Not Shown	27 II / 28 II Getting Started Manual	3368142	1
Not Shown	27 II / 28 II Users Manual CD	3368139	1

Lifetime Limited Warranty

Each Fluke 20, 70, 80, 170, 180 and 280 Series DMM will be free from defects in material and workmanship for its lifetime. As used herein, "lifetime" is defined as seven years after Fluke discontinues manufacturing the product, but the warranty period shall be at least ten years from the date of purchase. This warranty does not cover fuses, disposable batteries, damage from neglect, misuse, contamination, alteration, accident or abnormal conditions of operation or handling, including failures caused by use outside of the product's specifications, or normal wear and tear of mechanical components. This warranty covers the original purchaser only and is not transferable. For ten years from the date of purchase, this warranty also covers the LCD. Thereafter, for the lifetime of the DMM, Fluke will replace the LCD for a fee based on then current component acquisition costs.

To establish original ownership and prove date of purchase, please complete and return the registration card accompanying the product, or register your product on <http://www.fluke.com>. Fluke will, at its option, repair at no charge, replace or refund the purchase price of a defective product purchased through a Fluke authorized sales outlet and at the applicable international price. Fluke reserves the right to charge for importation costs of repair/replacement parts if the product purchased in one country is sent for repair elsewhere.

If the product is defective, contact your nearest Fluke authorized service center to obtain return authorization information, then send the product to that service center, with a description of the difficulty, postage and insurance prepaid (FOB Destination). Fluke assumes no risk for damage in transit. Fluke will pay return transportation for product repaired or replaced in-warranty. Before making any non-warranty repair, Fluke will estimate cost and obtain authorization, then invoice you for repair and return transportation.

THIS WARRANTY IS YOUR ONLY REMEDY. NO OTHER WARRANTIES, SUCH AS FITNESS FOR A PARTICULAR PURPOSE, ARE EXPRESSED OR IMPLIED. FLUKE SHALL NOT BE LIABLE FOR ANY SPECIAL, INDIRECT, INCIDENTAL OR CONSEQUENTIAL DAMAGES OR LOSSES, INCLUDING LOSS OF DATA, ARISING FROM ANY CAUSE OR THEORY. AUTHORIZED RESELLERS ARE NOT AUTHORIZED TO EXTEND ANY DIFFERENT WARRANTY ON FLUKE'S BEHALF. Since some states do not allow the exclusion or limitation of an implied warranty or of incidental or consequential damages, this limitation of liability may not apply to you. If any provision of this warranty is held invalid or unenforceable by a court or other decision-maker of competent jurisdiction, such holding will not affect the validity or enforceability of any other provision.

Fluke Corporation
P.O. Box 9090
Everett, WA 98206-9090
U.S.A.

Fluke Europe B.V.
P.O. Box 1186
5602 BD Eindhoven
The Netherlands

5/07

