

FLUKE®

718 Series

Pressure Calibrator

Users Manual

July 1998 Rev. 4, 3/06

© 1998-2006 Fluke Corporation. All rights reserved. Printed in U.S.A.

All product names are trademarks of their respective companies.

Table of Contents

Title	Page
Introduction.....	1
Safety Information	2
Getting Acquainted with the Calibrator	6
Power Saver	6
Switch Test.....	8
Zeroing with Absolute Pressure Modules	9
Calibrating a P/I Transmitter.....	10
Using the Internal Pump	10
Pump Valve Assembly Cleaning Instructions	15
Using an External Pump.....	16
External Fluke Pressure Module Compatibility	18
Sourcing Loop Voltage	19
Percent Error Setup.....	19
Maintenance.....	20
In Case of Difficulty.....	20
Cleaning	20
Calibration	20

Replacing the Batteries	21
Parts and Accessories	22
Specifications.....	25
Pressure Sensor Input	25
Pressure Module Input.....	25
DC mA Input	25
Loop Supply	25
General Specifications	26
How to Contact Fluke.....	27

List of Tables

Table	Title	Page
1.	Input Units	2
2.	Safety Information	3
3.	International Electrical Symbols.....	5
4.	Pushbutton Functions.....	7
5.	Pump Features	10
6.	Recommended Pressure Modules	14
7.	Fluke Pressure Module Compatibility	18
8.	Replacement Parts	22

List of Figures

Figure	Title	Page
1.	Connection Technique.....	5
2.	Front Panel Features.....	6
3.	Pump Features.....	9
4.	Internal Pressure Sensor with Internal Pump.....	12
5.	Pressure Module with Internal Pump.....	13
6.	Pressure Module with External Pump.....	17
7.	Sourcing Loop Voltage.....	19
8.	Battery Replacement.....	21
9.	Replacement Parts.....	24

Pressure Calibrator

Introduction

The Fluke 718 Series Pressure Calibrators do the following:

- Calibrate P/I (pressure to current) transmitters
- Measure pressure via a 1/8-inch NPT pressure fitting and an internal pressure sensor or via a Fluke 700 Series Pressure Module
- Source pressure
- Measure current up to 24 mA
- Simultaneously display pressure and current measurements.
- Supply loop voltage
- Calculate mA percentage in Percent Mode
- Calculate mA error % in Percent Error Mode

The 718 Pressure Calibrators (hereafter, “the Calibrator”) include:

- 718 1G
- 718 30G
- 718 100G
- 718 300G

The Calibrator makes 5-digit pressure readings in the following units: psi, inH₂O at 4 °C, inH₂O at 20 °C, kPa, cmH₂O at 4 °C, cmH₂O at 20 °C, bar, mbar, kg/cm², inHg, and mmHg.

Pressure sensor specifications are as listed under “Pressure Sensor Input”.

The Calibrator measures pressure sensor inputs in the units shown in Table 1.

For pressure modules, full scale readings for all pressure ranges can be made in psi, kPa, and inHg units. To avoid display overflow, full scale readings are limited to 1000 psi in cmH₂O, mbar, and mmHg units, and 3000 psi in inH₂O units. Pressures of at least 15 psi must be measured for meaningful readings in bar and kg/cm² units.

Your Calibrator is supplied with a holster, two installed 9 V alkaline batteries, one set of TL75 test leads, one set of AC70A alligator clips, one 700-ILF In-Line Filter (to protect the pump), a Product Overview Manual, and a CD-Rom.

If the Calibrator is damaged or something is missing, contact the place of purchase immediately. Contact your Fluke distributor for information about accessories. See

“How to Contact Fluke.” To order replacement parts or spares, see “Parts and Accessories.”

Table 1. Input Units

Displayed Pressure Units
psi
inH ₂ O at 4°C
inH ₂ O at 20°C
cmH ₂ O at 4°C
cmH ₂ O at 20°C
bar
mbar
kPa
inHg
mmHg
kg/cm ²

Safety Information

Use the Calibrator only as specified in this Users Manual, otherwise the protection provided by the Calibrator may be impaired.

A **Warning** identifies conditions and actions that pose hazard(s) to the user; a **Caution** identifies conditions and actions that may damage the Calibrator or the equipment under test.

Table 2. Safety Information

⚠ ⚠ Warning

To avoid possible electric shock or personal injury:

- Never apply more than 30 V between the mA terminals, or between either of the mA terminals and earth ground.
- Do not use the Calibrator to make measurements in a CAT II, CAT III, or a CAT IV environment.
CAT I equipment is designed to protect against transient from high-voltage, low-energy sources, such as electronic circuits or a copy machine
- Remove the test leads from the Calibrator before you open the battery door.
- Make sure the battery door is closed and latched before you operate the Calibrator.
- Do not operate the Calibrator if it is damaged.
- Do not operate the Calibrator around explosive gas, vapor, or dust.
- When using probes, keep fingers behind the finger guards on the probes.
- Use only two 9 V batteries, properly installed in the Calibrator case, to power the Calibrator.
- Follow all equipment safety procedures.
- Turn off circuit power before connecting the Calibrator mA and COM terminals in the circuit. Place Calibrator in series with the circuit.
- When servicing the Calibrator, use only specified replacement parts.
- Do not allow water inside the case.

Table 2. Safety Information (cont.)

⚠ ⚠ Warning

- To avoid false readings, which could lead to possible electric shock or personal injury, replace the battery as soon as the battery indicator  appears.
- To avoid a violent release of pressure in a pressurized system, shut off the valve and slowly bleed off the pressure before you attach or detach the internal pressure sensor or pressure module fitting to the pressure line.
- To avoid over pressure damages, do not apply pressure that exceeds the limits listed in the Pressure Specifications table in the “Specifications” section.
- To avoid mechanically damaging the Calibrator, do not apply torque between the pressure fitting and the Calibrator case. See Figure 1 for the proper use of tools.
- To avoid misleading readings, disconnect the pressure module connector at the Calibrator.
- To avoid damage to the pressure module, refer to the related *Instruction Sheet*.
- To avoid damage to the pump, use with dry air and non-corrosive gases only. Check test leads for continuity before using. Inspect Calibrator for cracks or damage, do not use the probes if they are damaged or show high resistance.

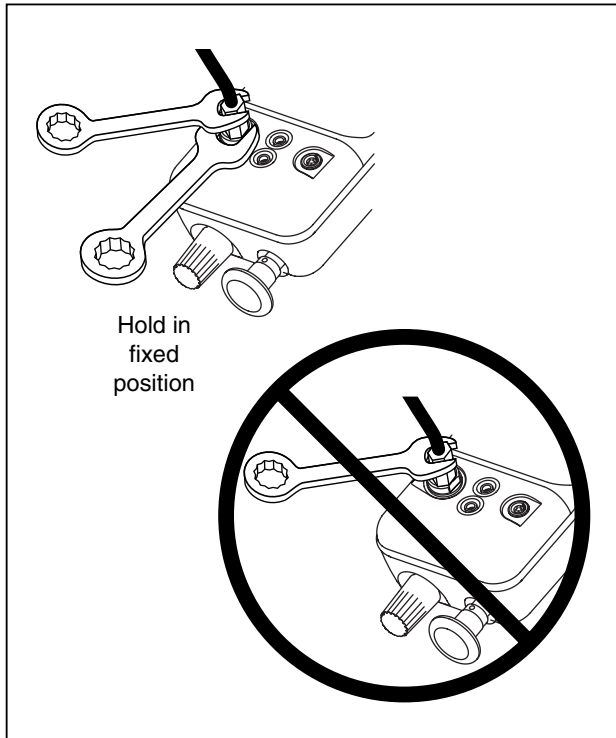

Figure 1. Connection Technique

wh001f.eps

Table 3. International Electrical Symbols

Symbol	Meaning
	Earth ground
	Fuse
	Battery
	Refer to this instruction sheet for information about this feature.
	Hazardous voltage. Risk of electric shock.
	Double insulated
	Conforms to relevant Canadian Standards Association directives.
	Conforms to relevant European Union directives
	Pressure

Getting Acquainted with the Calibrator

Press **Ⓢ** to turn the Calibrator on and off. The Calibrator displays pressure and current measurements simultaneously. See Figure 2.

The upper part of the display shows the applied pressure or vacuum. (Vacuum is shown as a negative value.) Press **UNITS** to select a different unit. When you cycle the power off and on, the Calibrator retains the unit you last used.

The lower part of the display shows the current (up to 24 mA) applied to the current (mA) inputs.

To source loop voltage, press **UNITS** while pressing **Ⓢ** on.

Pushbutton operation is described in Table 4. Pump features are shown in Figure 3 and described in Table 5.

Power Saver

The Calibrator automatically turns off after 30 minutes of inactivity. To reduce this time or disable this feature:

1. With the Calibrator OFF, press **Ⓢ**.
2. **P.S. xx** is displayed, where **xx** is the turn-off time in minutes. **OFF** means the power saver is disabled.
3. Press **HOLD** (**▼**) to decrease or **mA MODE** (**▲**) to increase the turn-off time.
4. To disable, press **HOLD** until the display shows **OFF**.

The Calibrator resumes normal operation after 2 seconds.

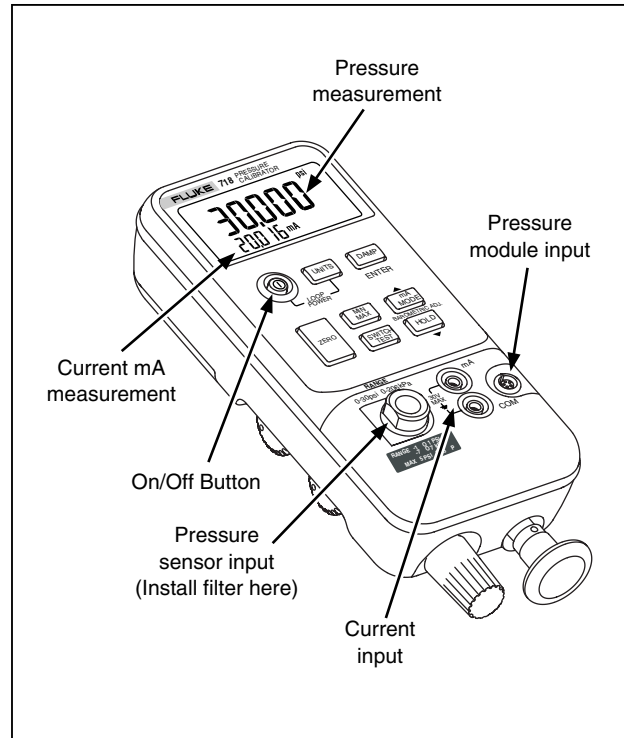













Figure 2. Front Panel Features

wh005f.eps

Table 4. Pushbutton Functions

Pushbutton	Description
	Press to select a different pressure unit. All units are available when the pressure sensor input is used. For higher pressure module inputs, inappropriate (out-of-range) units are not available. Press  on while pressing  to source loop voltage.
 	Turns pressure reading damping on and off. With damping on, the Calibrator averages several measurements before displaying a reading. Press to confirm selection of 0% and 100% output parameters.
	Press to zero the pressure display. Vent pressure to atmosphere before you press this pushbutton. With an Absolute Pressure Module, see special instructions below.
	Press to read the minimum pressure and current readings since power was turned on or the registers were cleared. Press again to read the maximum pressure and current readings since power was turned on. Press and hold for 3 seconds to clear the MIN/MAX registers.
	Press to perform switch test.
	Press to toggle the mA display mode between mA, mA Percent, and mA Percent Error.
	Press  to freeze the display. The HOLD symbol appears on the display. Press  again to resume normal operation.

Switch Test

To perform a switch test, do the following:

Note

This example uses a normally closed switch. The procedure is the same for an open switch but the display reads OPEN instead of CLOSE.

1. Connect the Calibrator mA and COM terminals to the switch using the pressure switch terminals and connect an external pump between the Calibrator and the pressure switch. The polarity of the terminals does not matter.

Note



If using an external pump, connect the pump to the Calibrator and to the input of the switch using a tee fitting.

2. Make sure the vent on the pump is open and zero the Calibrator if necessary. Close the vent after zeroing the Calibrator.

3. Press  to enter pressure switch test mode. The Calibrator will display CLOSE instead of a mA measurement.
4. Apply pressure with the pump slowly until the switch opens.

Note

In the switch test mode, the display update rate is increased to help capture changing pressure inputs. Even with the enhanced sample rate, pressuring the device under test should be done slowly to ensure accurate readings.

5. OPEN is displayed once the switch is open. Bleed the pump slowly until the pressure switch closes. RCL appears on the display.
 6. Press  to read the pressure values for when the switch opened, for when it closed, and for the deadband
- Hold  for 3 seconds to reset Switch Test mode; hold any other key for 3 seconds to exit.

Zeroing with Absolute Pressure Modules

For zeroing, adjust the Calibrator to read a known pressure. This can be barometric pressure, if it is accurately known, for all but the 700PA3 module. An accurate pressure standard can also apply a pressure within range for any Absolute Pressure Module. Adjust the Calibrator reading as follows:

1. Press and hold **ZERO** .
2. Press **mA MODE** (▲) to increase or **HOLD** (▼) to decrease the Calibrator reading to equal the applied pressure.
3. Release **ZERO** to exit the zeroing procedure.

Press the **UNITS** button to convert to any convenient measurement display unit.

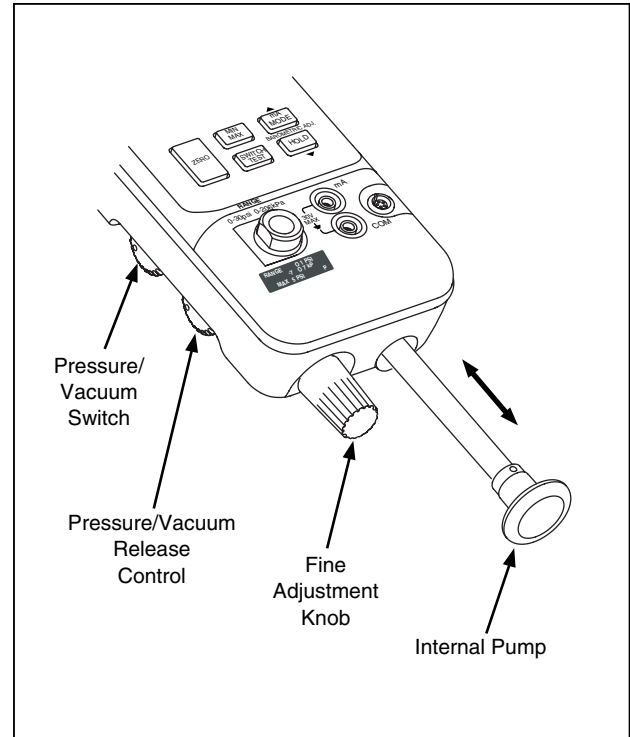

Figure 3. Pump Features

wh009f.eps

Table 5. Pump Features

Item	Description
Pressure Vacuum Switch	Rotate forward (clockwise) for pressure, backward (counter-clockwise) for vacuum.
Pressure Vacuum Release Valve	Rotate fully backward (counter-clockwise) to release all pressure or vacuum. (Rotate slightly for partial release.) Rotate fully forward (clockwise) to close valve.
Fine Adjustment Knob	Rotate either direction for precise adjustment of applied pressure or vacuum. Full rotation is about 30 turns.
Internal Pump	Increase pressure on the inward stroke. In vacuum mode, decrease pressure on the outward stroke.

Calibrating a P/I Transmitter

To calibrate a P/I (pressure to current) transmitter, apply a pressure to the transmitter and measure the transmitter's current loop output. You can apply pressure with the Calibrator's internal pump or with an external pump.

⚠ ⚠ Warning

To avoid a violent release of pressure or vacuum, always depressurize the system slowly using the pressure/vacuum release control before detaching any pressure line.

Using the Internal Pump

The internal pump can provide the rated pressure for all Model 718 Calibrators.

The preferred use for the internal pump is shown in Figure 4, where the Calibrator displays pressure measured with the internal sensor and provided by the internal pump.

The internal pump can also be used with certain Fluke 700 Series Pressure Modules. In this case, pressure measured by the Pressure Module is displayed by the Calibrator. Appropriate pressure modules for each Calibrator model are identified in Table 6 . Figure 5 shows the internal pump being used with a pressure module.

⚠⚠ Warning

If both a pressure module and the internal sensor are connected, the Calibrator displays ONLY the pressure module measurement.

To use the Calibrator's internal pump, refer to Figure 3 and perform the following steps:

1. Depressurize and drain the line before connecting the Calibrator.
2. Connect the pressure transmitter to the Calibrator internal sensor as shown in Figure 4 (for internal pressure sensor measurements) or Figure 5 (for pressure module measurements.)

Note

To avoid leaks, use Teflon tape or similar sealant on all pressure connections.
3. Make sure the pressure/vacuum switch is in the desired position. Forward (clockwise) is for pressure; backward (counter-clockwise) is for vacuum.
4. Turn the pressure/vacuum release control backward (counter-clockwise) to vent pressure/vacuum from the pump.
5. Press ZERO to zero the pressure display.

6. Turn the fine adjustment knob to mid-range.
7. Turn the pressure/vacuum release control forward (clockwise) to close the release valve.
8. Work the pump handle in and out to apply incrementally larger pressure/vacuum changes. Shorten the stroke to apply smaller increments of pressure/vacuum change.
9. To make very small pressure/vacuum changes, use the fine adjustment knob.

Note

This knob adjusts a small internal reservoir to vary the total volume. With larger external pressure/vacuum volumes, this control will adjust pressure or vacuum within a smaller range.
10. Depressurize the system before disconnecting the pressure line.

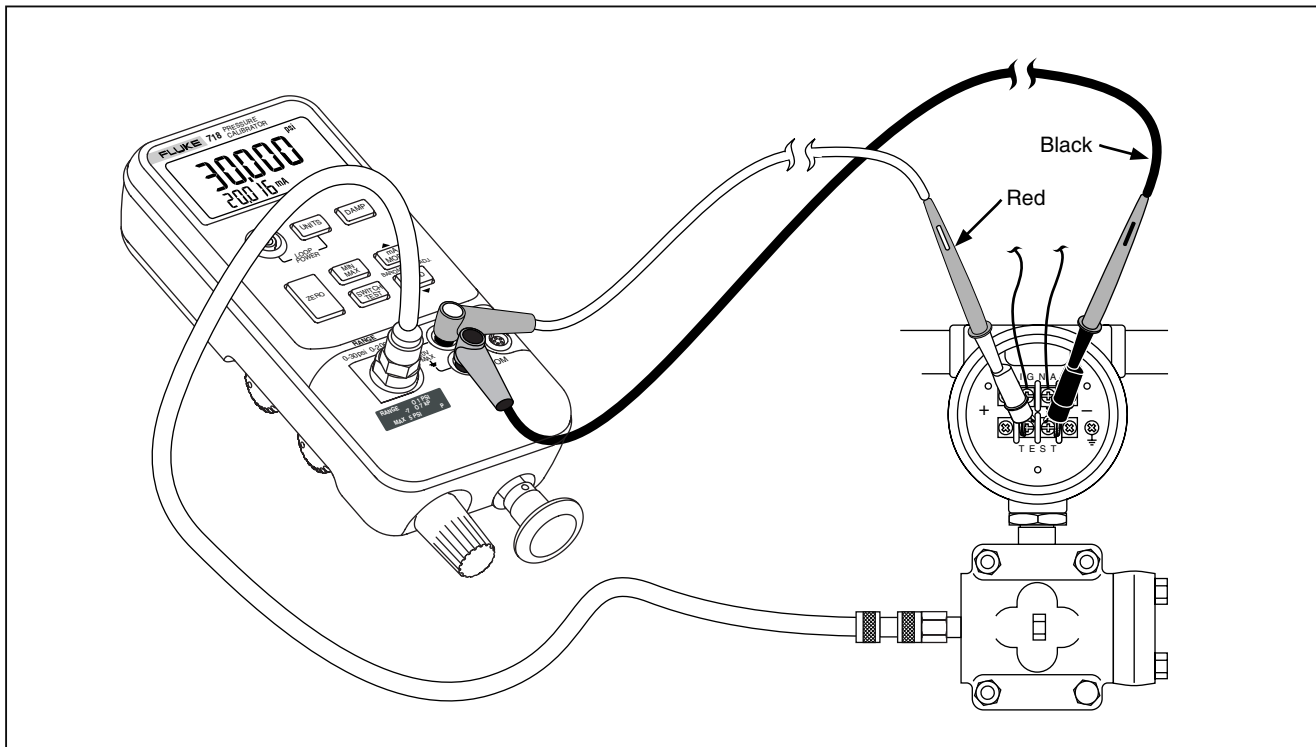

Figure 4. Internal Pressure Sensor with Internal Pump

wh002f.eps

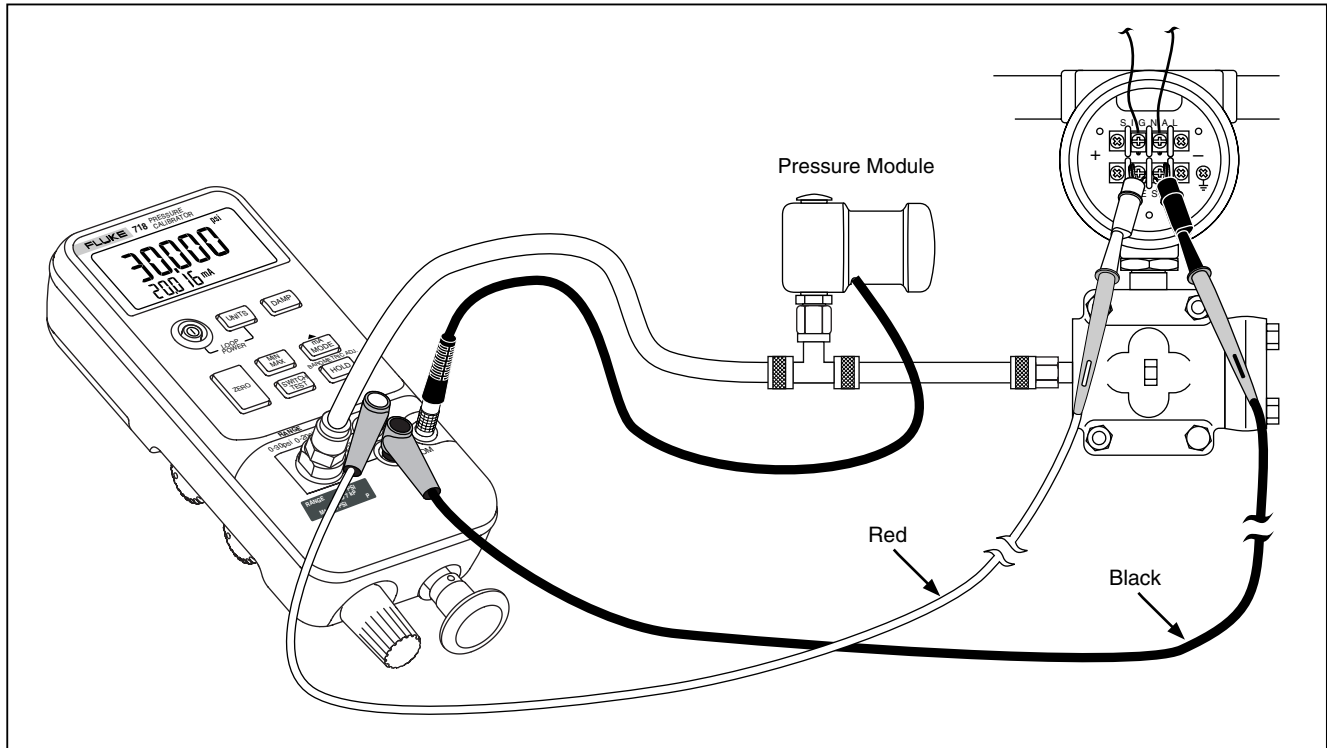

Figure 5. Pressure Module with Internal Pump

wh010f.eps

Table 6. Recommended Pressure Modules

Pressure Module	External Pump	Internal Pump			
	718 all models	718 1G	718 30G	718 100G	718 300G
700 P00	X	X			
700 P01	X	X			
700 P02	X	X	X	X	X
700 P22	X	X	X	X	X
700 P03	X		X	X	X
700 P23	X		X	X	X
700 P04	X		X	X	X
700 P24	X		X	X	X
700 P05	X		X	X	X
700 P06	X			X	X
700 P27	X				X
700 P07	X				
700 P08	X				
700 P09	X				

Pressure Module	External pump	Internal Pump			
	All 718 models	718 1G	718 30G	718 100G	718 300G
700 PA3	X		X	X	X
700 PA4	X		X	X	X
700 PA5	X		X	X	X
700 PA6	X			X	X
700 PV3	X		X	X	X
700 PV4	X		X	X	X
700 PD2	X	X	X	X	X
700 PD3	X		X	X	X
700 PD4	X		X	X	X
700 PD5	X		X	X	X
700 PD6	X			X	X
700 PD7	X				X
700 D29	X				
700 P30	X				
700 P31	X				

Pump Valve Assembly Cleaning Instructions

1. Using a small screwdriver, remove the two valve retention caps located in the oval shaped opening on the underside of the Calibrator.
2. After the caps have been removed, gently remove the spring and o-ring assembly.
3. Set aside the valve assemblies in a safe area and clean out the valve body using a cotton swab soaked in IPA (isopropyl alcohol).
4. Repeat this process several times using a new cotton swab each time until there is no remaining sign of residue.
5. Pump the unit several times and check again for residue.
6. Clean the o-ring assembly and o-ring on the retention caps with IPA and inspect the o-rings closely for any cuts, nicks, or wear. Replace if needed.
7. Inspect the springs for wear or loss of tension. They should be approximately 8.6 mm long in the relaxed state. If they are shorter than this, they may not allow the o-ring to seat properly. Replace if needed.
8. Once all parts have been cleaned and inspected, reinstall the o-ring and spring assemblies into the valve body.
9. Reinstall the retention caps and gently tighten the cap.
10. Seal the output of the Calibrator and pump up the unit to at least 50 % its rated pressure.
11. Release the pressure and repeat several times to ensure that the o-rings seat properly.

The Calibrator is now ready for use.

Using an External Pump

Warning

To avoid damage to the Calibrator and possible release of pressure, do not connect the internal sensor to an external pressure source that exceeds the maximum rated pressure.

To develop higher pressure or vacuum, use an external pump (such as the Fluke Model 700PTP). Use a Fluke Pressure Module connected to the pressure module input on the Calibrator. Pressure modules are listed in Table . Make overall connections as shown in Figure 6.

Refer to setup and operating instructions included with the pressure module and pump.

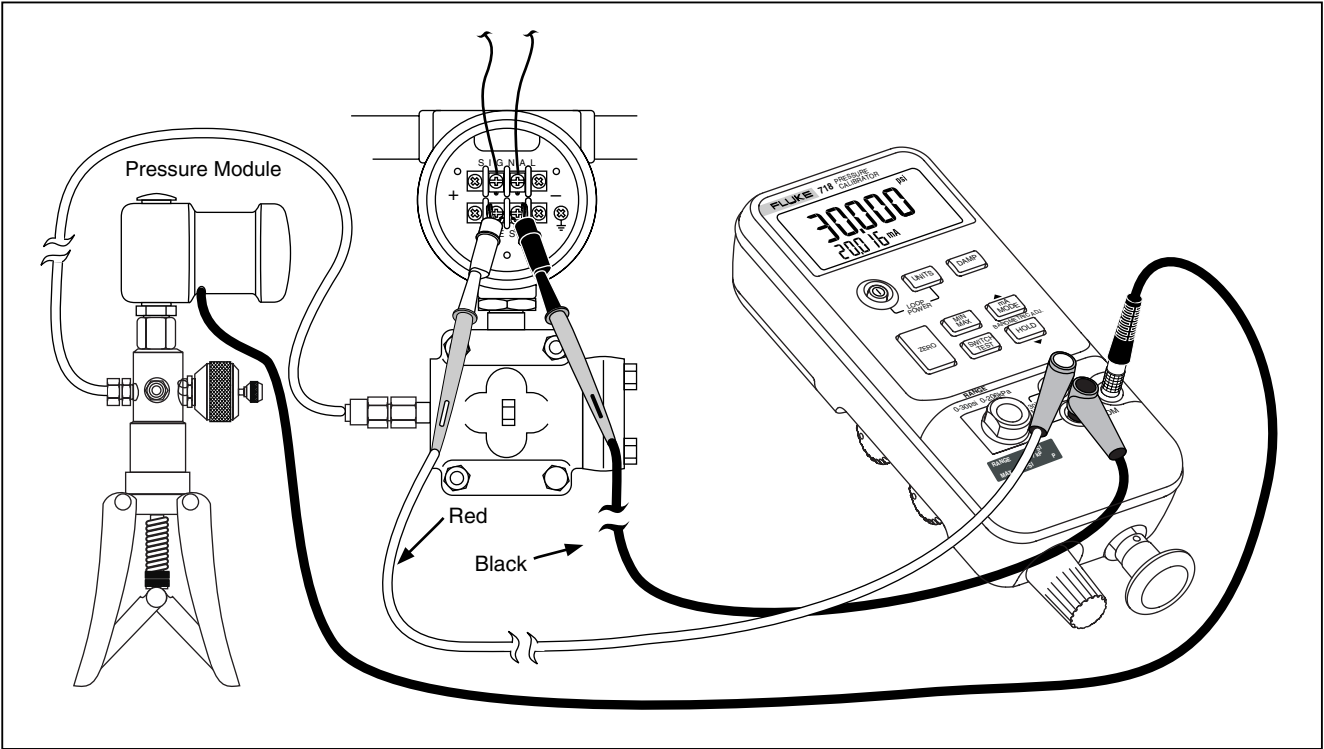

Figure 6. Pressure Module with External Pump

wh006f.eps

External Fluke Pressure Module Compatibility

If inappropriate units are selected, the output of Fluke 700P Pressure Modules can cause the Calibrator display to overflow (OL), or displays values that are too low to be read. Refer to Table 7 for appropriate unit and range compatibility.

Table 7. Fluke Pressure Module Compatibility

Pressure Unit	Module Compatibility
psi	Available on all pressure ranges
inH ₂ O	All ranges through 3000 psi
cmH ₂ O	All ranges through 1000 psi
bar	15 psi and above
mbar	All ranges through 1000 psi
kPa	Available on all pressure ranges
inHg	Available on all pressure ranges
mmHg	All ranges through 1000 psi
kg/cm ²	15 psi and above

Sourcing Loop Voltage

The Calibrator can supply loop power at 24 V dc to a current transmitter that is disconnected from the system. Use the following procedure:

1. With power off, hold down **UNITS** while pressing **Ⓢ** on. The “Loop Power” icon appears in the display.
2. With the transmitter disconnected from normal loop power, connect the Calibrator mA (+) and COM (-) test leads in series with the instrument current loop as shown in Figure 7.
3. Measure loop current in the mA display.
4. Press **Ⓢ** off to deactivate the 24 V dc supply when you are done sourcing loop voltage.

In addition to mA, the current can be displayed in two alternative modes:

- **Percent Mode-** The current is displayed as a percentage based on a 4-20 mA scale.
 - **Percent Error Mode-** Transmitter current output error is displayed. Error is calculated based on a configurable zero and span pressure and a 4-20 mA scale.
1. Measure loop current in the mA measurement display.
 2. Press **Ⓢ** OFF to deactivate the 24 V dc supply when you are done sourcing loop voltage.

Percent Error Setup

Press and hold **mA MODE**. After 3 seconds the set icon and 0% appears on the lower display. Use **▼** and **▲** to adjust the 0% point for the Percent Error calculation, then press **DAMP** (ENTER) key to confirm selection. Press **mA MODE**. 100% is displayed on the lower display. Use **▼** and **▲** to adjust the 100% point for the Percent Error calculation. Press **DAMP** (ENTER) to confirm the selection and to exit.

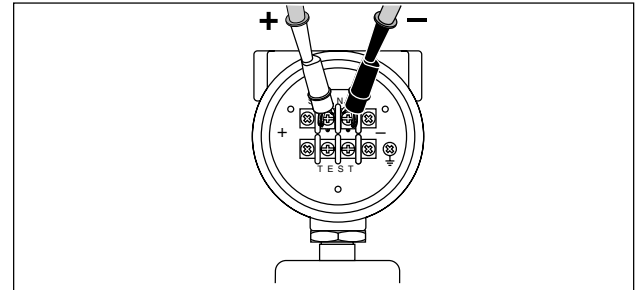

qo007f.eps

Figure 7. Sourcing Loop Voltage

Maintenance

⚠ ⚠ Warning

To avoid possible electric shock, personal injury, or sudden release of pressure, review “Safety Information” earlier in this manual before proceeding.

Remove test leads before opening.

For maintenance procedures not described in this instruction sheet, or if the Calibrator needs repair, contact a Fluke Service Center.

In Case of Difficulty

- Check the battery, test leads, pressure module, and pressure tubing. Follow replacement and connection instructions properly.
- Review this instruction sheet to make sure you are using the Calibrator correctly.

If the Calibrator needs repair, and the Calibrator is under warranty, see the warranty statement for terms. If the warranty has lapsed, the Calibrator can be repaired and returned for a fixed fee.

Cleaning

Periodically wipe the case with a damp cloth and detergent; do not use abrasives or solvents.

Calibration

Fluke recommends that you calibrate your Calibrator once a year to ensure that it performs according to its specifications. A calibration manual is available (PN 686540). Call 1-800-526-4731 from the U.S.A. and Canada. In other countries, contact a Fluke Service Center.

Replacing the Batteries

When the  symbol appears on the display, replace the two 9 V alkaline batteries. Refer to Figure 8.

Warning

To avoid false readings, which could lead to possible electric shock or personal injury, replace the batteries as soon as the battery indicator  appears.

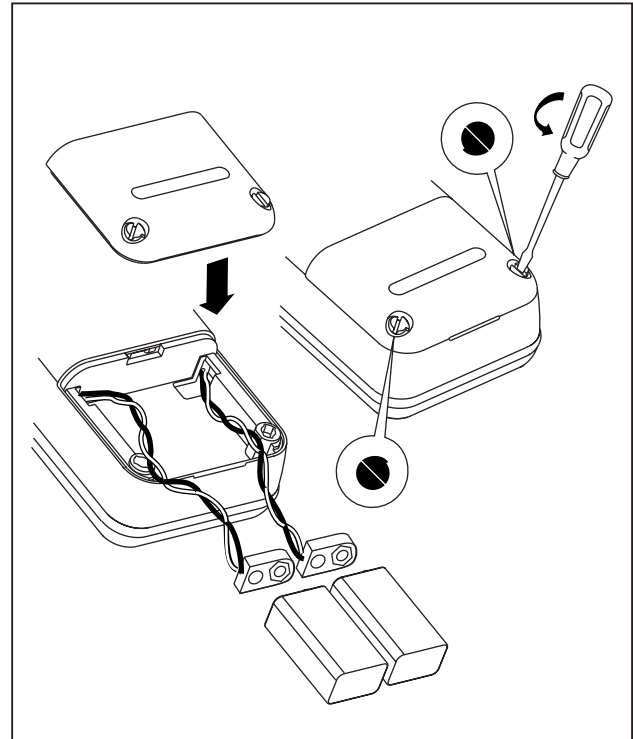

wh008f.eps

Figure 8. Battery Replacement

Parts and Accessories

Refer to Table 8 and Figure 9.

Table 8. Replacement Parts

Item	Description	Part/ Mod. No.	Qty
AC72	Alligator clip red	1670641	1
	Alligator clip black	1670652	1
BT1, BT2	9 V battery, ANSI/NEDA 1604A or IEC 6LR61	614487	2
Holster	Holster, Yellow	664182	1
H2, 3, 4	Case screw	832246	3
H5, 6	Battery door fasteners	948609	2
H7, 8	Bracket screw	641131	2
MP1	LCD bezel, 718 30G	664158	1
MP1	LCD bezel, 718 100G	664169	1
MP1	LCD bezel, 718 1G	2545047	1
MP1	LCD bezel, 718 300G	2545058	1
MP2	LCD	686482	1
MP3, 4	Pump retainer bracket	664201	2
MP5	Gasket	664208	1
MP6	1G pump	2571725	1
	30G, 100G and 300G pump	2558508	1
MP7, 8	Selector knob	664193	2
MP9	Vernier adjust knob	664190	1

Table 8. Replacement Parts (cont.)

Item	Description	Part/ Mod. No.	Qty
MP10	Pump handle knob	664185	1
MP11, 12, 13	O-ring	146688	3
MP14	Spacer	687449	1
MP85	Case top/connector, 718 1G, 30G, 100G, 300G	2546299	1
MP86	Case bottom	664174	1
MP89, 90	Non-skid foot	885884	2
MP92	Battery door	664177	1
S1	Keypad	2113087	1
TL20	Industrial test lead set	1639457	Opt
TL75	Test lead set	855742	1
TM1	718 Product Overview Manual	1549632	1
-	718 CD-ROM (contains Users Manual)	1574463	1
-	71X Series Calibration Manual	686540	Opt
-	Pump (with cleanout) rebuild kit	2553919	Opt
-	718 1G Top Case Decal	2546993	1
-	718 30G Top Case Decal	2547000	1
-	718 100G Top Case Decal	2547017	1
-	718 300G Top Case Decal	2547021	1

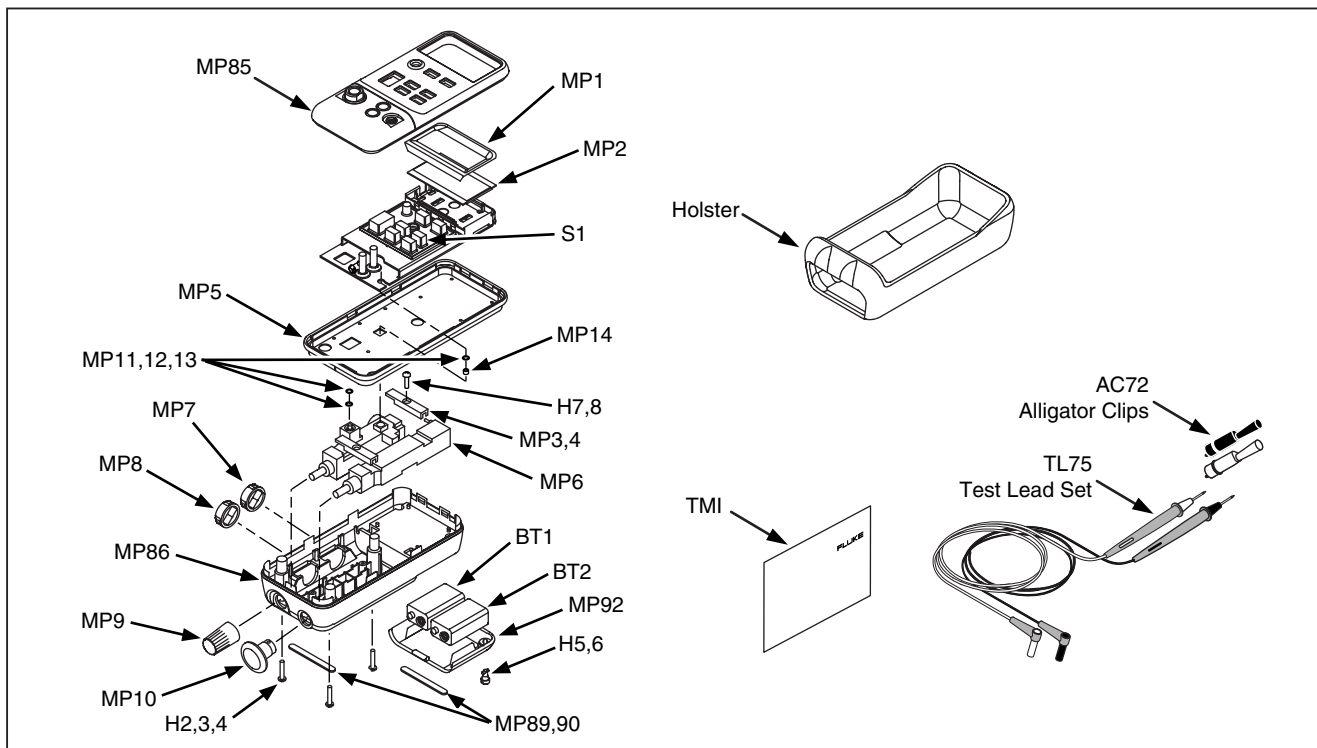

Figure 9. Replacement Parts

wh004f.eps

Specifications

Specifications are based on a one year calibration cycle and apply for ambient temperature from +18 °C to +28 °C unless stated otherwise. "Counts" are the number of increments or decrements of the least significant digit.

Pressure Sensor Input

Model	Range	Accuracy	Max Non-destructive Pressure
1G	-1 to 1 PSI (-7 to 8 kPa)	± 0.05 % of Range	5 PSI (34.5 kPa)
30G	-12 to 30 PSI (-83 to 207 kPa)		60 PSI (413 kPa)
100G	-12 to 100 PSI (-83 to 690 kPa)		200 PSI (1.4 mPa)
300G	-12 to 300 PSI (-83 to 2068 kPa)		375 PSI (2.6 mPa)
<p><i>Temperature coefficient: 0.01 % of range per °C for temperature ranges -10 °C to 18 °C and 28 °C to 55 °C</i></p>			

Pressure Module Input

Range	Resolution	Accuracy
(determined by Pressure Module)		

DC mA Input

Range	Resolution	Accuracy, ±(% of Reading + Counts)
24 mA	0.001 mA	0.015 + 2
<p><i>Fuseless overload protection</i></p> <p><i>Temperature coefficient: 0.005 % of range per °C for temperature ranges -10 °C to 18 °C and 28 °C to 55 °C</i></p>		

Loop Supply

24 V dc nominal

General Specifications

Maximum voltage applied between either mA terminal and earth ground or between the mA terminals: 30 V

Storage temperature: -40 °C to 60 °C

Operating temperature: -10 °C to 55 °C

Operating altitude: 3000 meters maximum

Relative humidity: 95 % up to 30 °C, 75 % up to 40 °C, 45 % up to 50 °C, and 35 % up to 55 °C

Vibration: Random 2 g, 5 Hz to 500 Hz per MIL-PRF-28800F Class 2

Shock: 1 meter drop test, per IEC 61010-1

Safety: Certified as compliant to ISA-82.02.01 (IEC 61010-1 Mod) CSA C22.2 No. 1010.1

Protection Class: Class 2, Double insulated

Power requirements: Two 9 V batteries (ANSI/NEDA 1604A or IEC 6LR61)

Size: 60 mm H x 87 mm W x 210 mm L (2.38 in H x 3.41 in W x 8.28 in L); with holster: 66 mm H x 94 mm W x 216 mm L (2.61 in H x 3.72 in W x 8.5 in L)

Weight: 737 g (26 oz); with holster: 992 g (35 oz)

LIMITED WARRANTY & LIMITATION OF LIABILITY

This Fluke product will be free from defects in material and workmanship for three years (one year for pump assembly) from the date of purchase. This warranty does not cover fuses, disposable batteries or damage from accident, neglect, misuse or abnormal conditions of operation or handling. Resellers are not authorized to extend any other warranty on Fluke's behalf. To obtain service during the warranty period, send your defective Calibrator to the nearest Fluke Authorized Service Center with a description of the problem.

THIS WARRANTY IS YOUR ONLY REMEDY. NO OTHER WARRANTIES, SUCH AS FITNESS FOR A PARTICULAR PURPOSE, ARE EXPRESSED OR IMPLIED. FLUKE IS NOT LIABLE FOR ANY SPECIAL, INDIRECT, INCIDENTAL OR CONSEQUENTIAL DAMAGES OR LOSSES, ARISING FROM ANY CAUSE OR THEORY. Since some states or countries do not allow the exclusion or limitation of an implied warranty or of incidental or consequential damages, this limitation of liability may not apply to you.

How to Contact Fluke

To order accessories, receive operating assistance, or get the location of the nearest Fluke distributor or Service Center, call:

USA: 1-888-99-FLUKE (1-888-993-5853)

Canada: 1-800-36-FLUKE (1-800-363-5853)

Europe: +31 402-675-200

Japan: +81-3-3434-0181

Singapore: +65-738-5655

Anywhere in the world: +1-425-446-5500

Or, visit Fluke's Web site at www.fluke.com.

Address correspondence to:

Fluke Corporation

P.O. Box 9090,

Everett, WA 98206-9090

U.S.A.

Fluke Europe B.V.

P.O. Box 1186,

5602 BD Eindhoven

The Netherlands

