

# **753/754**

Documenting Process Calibrator

Calibration Manual

### **LIMITED WARRANTY AND LIMITATION OF LIABILITY**

Each Fluke product is warranted to be free from defects in material and workmanship under normal use and service. The warranty period is three years and begins on the date of shipment. Parts, product repairs, and services are warranted for 90 days. This warranty extends only to the original buyer or end-user customer of a Fluke authorized reseller, and does not apply to fuses, disposable batteries, or to any product which, in Fluke's opinion, has been misused, altered, neglected, contaminated, or damaged by accident or abnormal conditions of operation or handling. Fluke warrants that software will operate substantially in accordance with its functional specifications for 90 days and that it has been properly recorded on non-defective media. Fluke does not warrant that software will be error free or operate without interruption.

Fluke authorized resellers shall extend this warranty on new and unused products to end-user customers only but have no authority to extend a greater or different warranty on behalf of Fluke. Warranty support is available only if product is purchased through a Fluke authorized sales outlet or Buyer has paid the applicable international price. Fluke reserves the right to invoice Buyer for importation costs of repair/replacement parts when product purchased in one country is submitted for repair in another country. Fluke's warranty obligation is limited, at Fluke's option, to refund of the purchase price, free of charge repair, or replacement of a defective product which is returned to a Fluke authorized service center within the warranty period.

To obtain warranty service, contact your nearest Fluke authorized service center to obtain return authorization information, then send the product to that service center, with a description of the difficulty, postage and insurance prepaid (FOB Destination). Fluke assumes no risk for damage in transit. Following warranty repair, the product will be returned to Buyer, transportation prepaid (FOB Destination). If Fluke determines that failure was caused by neglect, misuse, contamination, alteration, accident, or abnormal condition of operation or handling, including overvoltage failures caused by use outside the product's specified rating, or normal wear and tear of mechanical components, Fluke will provide an estimate of repair costs and obtain authorization before commencing the work. Following repair, the product will be returned to the Buyer transportation prepaid and the Buyer will be billed for the repair and return transportation charges (FOB Shipping Point).

**THIS WARRANTY IS BUYER'S SOLE AND EXCLUSIVE REMEDY AND IS IN LIEU OF ALL OTHER WARRANTIES, EXPRESS OR IMPLIED, INCLUDING BUT NOT LIMITED TO ANY IMPLIED WARRANTY OF MERCHANTABILITY OR FITNESS FOR A PARTICULAR PURPOSE. FLUKE SHALL NOT BE LIABLE FOR ANY SPECIAL, INDIRECT, INCIDENTAL OR CONSEQUENTIAL DAMAGES OR LOSSES, INCLUDING LOSS OF DATA, ARISING FROM ANY CAUSE OR THEORY.**

Since some countries or states do not allow limitation of the term of an implied warranty, or exclusion or limitation of incidental or consequential damages, the limitations and exclusions of this warranty may not apply to every buyer. If any provision of this Warranty is held invalid or unenforceable by a court or other decision-maker of competent jurisdiction, such holding will not affect the validity or enforceability of any other provision.

Fluke Corporation  
P.O. Box 9090  
Everett, WA 98206-9090  
U.S.A.

Fluke Europe B.V.  
P.O. Box 1186  
5602 BD Eindhoven  
The Netherlands

# ***Table of Contents***

<b>Title</b>	<b>Page</b>
Introduction.....	1
How to Contact Fluke.....	1
Safety Information.....	2
Symbols.....	3
Specifications.....	4
General Specifications.....	4
Environmental Specifications.....	4
Standards and Agency Approval Specifications.....	4
Detailed Specifications.....	4
DC mV Measurement.....	4
DC Voltage Measurement.....	5
AC Voltage Measurement.....	5
DC Current Measurement.....	5
Resistance Measurement.....	5
Continuity Testing.....	5
Frequency Measurement.....	6
±DC Voltage Output.....	6
+DC Current Source.....	6
+DC Current Simulate (External Loop Power).....	6
Resistance Sourcing.....	6
Frequency Sourcing.....	7
Temperature, Thermocouples.....	7
Temperature, Resistance Temperature Detectors.....	8
Loop Power.....	8
Performance Verification Tests.....	9
Verification Equipment.....	9
How to Verify.....	10
DC Volts Measurement.....	10
AC Volts Measurement.....	12
DC Current Measurement.....	13
Resistance Measurement.....	14
Frequency Measurement.....	16
DC Volts Source.....	17
DC Current Source.....	18
Simulate Transmitter Function.....	19
Resistance Source Function.....	20

Frequency Source.....	21
Thermocouple Measure.....	23
Thermocouple Source .....	25
RTD Measure, Four-Wire .....	26
RTD Measure, Three-Wire .....	27
RTD Source.....	29
Loop Power .....	30
HART Mode Verification (754 Only) .....	30
Calibration .....	32
Equipment Required for Calibration .....	32
Calibration Status Indicator .....	32
How to Enter Calibration.....	32
Calibration Constant Out of Bounds .....	33
How to Calibrate .....	33
Maintenance.....	35
Battery Replacement .....	35
How to Clean the Product.....	35
Calibration Data.....	36
In Case of Difficulty .....	36
Service Center Calibration or Repair.....	36
Replaceable Parts .....	37
Accessories .....	41

# **List of Tables**

<b>Table</b>	<b>Title</b>	<b>Page</b>
1.	Symbols.....	3
2.	Equipment Required for Verification.....	9
3.	DC Volts Measurement Verification Points.....	11
4.	AC Volts Measurement Verification Points.....	12
5.	DC Current Measurement Verification Points.....	14
6.	Resistance Measurement Verification Points.....	15
7.	Frequency Measurement Verification Points.....	16
8.	DC Volts Source Verification Points.....	17
9.	DC Current Source Verification Points.....	18
10.	Simulate Transmitter Verification Points.....	20
11.	Resistance Source Verification Points.....	21
12.	Frequency Source Verification Points.....	22
13.	Temperature Measure Verification.....	25
14.	Temperature Source Verification (Type-K Thermocouple, ITS-90).....	26
15.	RTD Measure Verification (100W Pt (385), Four-Wire Connection).....	27
16.	RTD Measure Verification (100W Pt (385), Three-Wire Connection).....	28
17.	RTD Source Verification (100W Pt (385)).....	29
18.	Replacement Parts.....	37
19.	Accessories.....	41



# *List of Figures*

<b>Figure</b>	<b>Title</b>	<b>Page</b>
1.	DC Volts and AC Volts Measurement Connections .....	11
2.	DC Current Measurement Verification Connections .....	13
3.	Resistance Measurement Verification Connections .....	15
4.	Frequency Measurement Verification Connections .....	16
5.	DC Volts Source Verification Connections .....	17
6.	DC Current Source Verification Connections .....	18
7.	Simulate Transmitter Verification Connections .....	19
8.	Resistance Source Verification Connections .....	20
9.	Frequency Source Verification Connections .....	22
10.	Temperature Measure (TC) Verification Connections .....	24
11.	Four-Wire RTD Measure Verification Connections .....	27
12.	Three-Wire RTD Measure Verification Connections .....	28
13.	Loop Power Verification Connections .....	30
14.	Active Device Screen .....	31
15.	HART Mode Verification Connections .....	32
16.	Parts .....	40





## **Introduction**

This manual contains data necessary to do performance verification tests and calibration adjustments on your 753 and 754 Documenting Process Calibrators (the Product).

## **How to Contact Fluke**

To contact Fluke, call one of the following telephone numbers:

- Technical Support USA: 1-800-44-FLUKE (1-800-443-5853)
- Calibration/Repair USA: 1-888-99-FLUKE (1-888-993-5853)
- Canada: 1-800-36-FLUKE (1-800-363-5853)
- Europe: +31 402-675-200
- Japan: +81-3-6714-3114
- Singapore: +65-738-5655
- Anywhere in the world: +1-425-446-5500

Or, visit Fluke's website at [www.fluke.com](http://www.fluke.com)

To register your product, visit <http://register.fluke.com>

To view, print, or download the latest manual supplement, visit <http://us.fluke.com/usen/support/manuals>

The latest software trial version of DPCTrack2 can be downloaded at [www.fluke.com/DPCTrack](http://www.fluke.com/DPCTrack) . For more information see "Communication with a PC".

753/754 Accessories can be found at [www.fluke.com/process\\_acc](http://www.fluke.com/process_acc)

## **Safety Information**

A Warning identifies condition and procedures that are dangerous to the user. A Caution identifies conditions and procedures that can cause damage to the Product or the equipment under test.

### **Warning**

**To prevent personal injury, use the Product only as specified, or the protection supplied by the Product can be compromised.**

**To prevent possible electrical shock, fire, or personal injury:**















- **Read all safety Information before you use the Product.**
- **Carefully read all instructions.**
- **Use only correct measurement category (CAT), voltage, and amperage rated probes, test leads, and adapters for the measurement.**
- **The battery must be locked in place before you operate the Product.**
- **Recharge the battery when the low battery indicator shows to prevent incorrect measurements.**
- **Do not apply more than the rated voltage, between the terminals or between each terminal and earth ground.**
- **Limit operation to the specified measurement category, voltage, or amperage ratings.**
- **Do not exceed the Measurement Category (CAT) rating of the lowest rated individual component of a Product, probe, or accessory.**
- **Measure a known voltage first to make sure that the Product operates correctly.**
- **Do not touch voltages > 30 V ac rms, 42 V ac peak, or 60 V dc.**
- **Do not use the Product around explosive gas, vapor, or in damp or wet environments.**
- **Do not use, and disable the Product if it is damaged.**
- **Do not use the Product if it operates incorrectly.**
- **Keep fingers behind the finger guards on the probes.**
- **Remove all probes, test leads, and accessories that are not necessary for the measurement.**
- **Only use probes, test leads, and accessories that have the same measurement category, voltage, and amperage ratings as the Product.**

- **Connect the common test lead before the live test lead and remove the live test lead before the common test lead.**
- **Use only current probes, test leads, and adapters supplied with the Product.**
- **Do not touch the probes to a voltage source when the test leads are connected to the current terminals.**
- **Use only cables with correct voltage ratings.**
- **Do not use test leads if they are damaged. Examine the test leads for damaged insulation, exposed metal, or if the wear indicator shows. Check test lead continuity.**
- **Examine the case before you use the Product. Look for cracks or missing plastic. Carefully look at the insulation around the terminals.**

## Symbols

Symbols used on the Product and in this manual are shown in Table 1.

**Table 1. Symbols**

Symbol	Meaning	Symbol	Meaning
	Earth ground		Common (LO) Input equipotentiality
	AC- alternating current		Conforms to relevant North American Safety Standards.
	DC- direct current		Conforms to European Union directives.
	Risk of danger. Important information. See manual.		Pressure
	Hazardous voltage. Risk of electrical shock.		Do not dispose of this product as unsorted municipal waste. Go to Fluke's website for recycling information.
	Application around and removal from HAZARDOUS LIVE conductors is permitted.		Conforms to relevant Australian standards.
	Double insulated		German certifying body.
<b>CAT II</b>	CAT II equipment is designed to protect against transients from energy-consuming equipment supplied from the fixed installation, such as TVs, PCs, portable tools, and other household appliances.		

## Specifications

### General Specifications

All specifications apply from +18 °C to +28 °C unless stated otherwise.

All specifications assume a 5-minute warmup period.

Measurement specifications are valid only when Damping is turned on. When damping is turned off, or when the annunciator is shown, floor specifications are multiplied by 3. Floor specifications are the second part of the specifications. The measure pressure, temperature, and frequency functions are specified only with damping on.

Specifications are valid to 110 % of range. The following exceptions are valid to 100 % of range: 300 V dc, 300 V ac, 22 mA source and simulate, 15 V dc source, and temperature measure and source.

To achieve the best noise rejection, use battery power.

<b>Size (H x W x L)</b> .....	Height = 63.35 mm (2.49 inches) x Width = 136.37 mm (5.37 inches) x Length = 244.96 mm (9.65 inches)
<b>Weight</b> .....	1.23 kg (2.71 lb) (Batteries included)
<b>Display</b> .....	480 by 272 pixel graphic LCD, 95 x 54 mm
<b>Power</b> .....	Internal battery pack: Lithium Ion, 7.2 V dc, 30 Wh

### Environmental Specifications

<b>Operating Altitude</b> .....	3000 m (9842 ft)
<b>Storage Altitude</b> .....	13000 m (42650 ft)
<b>Operating Temperature</b> .....	-10 to 50 °C
<b>Storage Temperature</b> .....	-20 to 60 °C
<b>Relative Humidity (Maximum, non-condensing)</b> .....	90 % to 35 °C 75 % to 40 °C 45 % to 50 °C

### Standards and Agency Approval Specifications

<b>Protection Class</b> .....	Pollution Degree II IP 52
<b>Double Insulation Creepage and Clearance</b> .....	Per IEC 61010-1
<b>Installation Category</b> .....	300 V CAT II
<b>Design Standards and Compliance</b> .....	EN/IEC 61010-1:2010, CAN/CSA C22.2 No. 61010-1-04, ANSI/UL 61010-1:2004
<b>EMI, RFI, EMC</b> .....	EN 61326-1:2006
<b>RF Fields</b> .....	Accuracy for all functions is not specified in RF fields >3 V/m

### Detailed Specifications

Specifications valid after a 5-minute warmup.

Specifications are valid to 110 % of Range with the following exceptions: 300 V dc measure, 300 V ac measure, 50 kHz measure and source, 22 mA source and simulate, 15 V dc source, and temperature measure and source which are valid to 100 % of range.

#### DC mV Measurement

Range	Resolution	% of Reading + Floor	
		1-Year	2 Year
±100.000 mV	0.001 mV	0.02 % + 0.005 mV	0.03 % + 0.005 mV
Input Impedance: >5 MΩ Maximum Input Voltage: 300 V, IEC 61010 300 V CAT II Temperature coefficient: (0.001 % of reading + 0.001% of range) / °C (<18 °C or >28 °C) Normal mode rejection: >100 dB at 50 or 60 Hz nominal			

**DC Voltage Measurement**

Range	Resolution	% of Reading + Floor	
		1-Year	2 Year
±3.00000 V	0.00001 V	0.02 % + 0.00005 V	0.03 % + 0.00005 V
±30.0000 V	0.0001 V	0.02 % + 0.0005 V	0.03 % + 0.0005 V
±300.00 V	0.01 V	0.05 % + 0.05 V	0.07 % + 0.05 V

Input Impedance: >4 MΩ  
 Maximum Input Voltage: 300 V, IEC 61010 300V CAT II  
 Temperature coefficient: (0.001 % of reading + 0.0002 % of range) / °C (<18 °C or >28 °C)  
 Normal mode rejection: >100 dB at 50 or 60 Hz nominal

**AC Voltage Measurement**

Range 40 Hz – 500 Hz	Resolution	% of Reading + Floor	
		1-Year	2 Year
3.000 V	0.001 V	0.5 % + 0.002 V	1.0 % + 0.004 V
30.00 V	0.01 V	0.5 % + 0.02 V	1.0 % + 0.04 V
300.0 V	0.1 V	0.5 % + 0.2 V	1.0 % + 0.2 V

Input Impedance: >4 MΩ and <100 pF  
 Input Coupling: AC  
 Maximum Input Voltage: 300 V, IEC 61010 300V CAT II  
 Temperature coefficient: 5 % of specified accuracy / °C (<18 °C or >28 °C)  
 Specifications apply for 9 % to 100 % of voltage range.

**DC Current Measurement**

Range	Resolution	% of Reading + Floor	
		1-Year	2 Year
±30.000 mA	1 μA	0.01 % + 5 μA	0.015 % + 7 μA
±100.00 mA	10 μA	0.01 % + 20 μA	0.015 % + 30 μA

Maximum Input: 110 mA  
 Maximum Burden Voltage: 420 mV at 22 mA  
 Temperature coefficient: 3 % of specified accuracy / °C (<18 °C or >28 °C)  
 No Fuse  
 Normal mode rejection: 90 dB at 50 or 60 Hz nominal, and 60 dB at 1200 Hz and 2200 Hz nominal (HART signals)

**Resistance Measurement**

Range	Resolution	% of Reading + Floor		Source Current
		1-Year	2 Year	
10.000 Ω	0.001 Ω	0.05 % + 0.050 Ω	0.07 % + 0.070 Ω	3 mA
100.00 Ω	0.01 Ω	0.05 % + 0.05 Ω	0.07 % + 0.07 Ω	1 mA
1.0000 kΩ	0.1 Ω	0.05 % + 0.0005 kΩ	0.07 % + 0.0007 kΩ	500 μA
10.000 kΩ	1 Ω	0.10 % + 0.010 kΩ	0.15 % + 0.015 kΩ	50 μA

Open-circuit voltage: 5 V nominal  
 Temperature coefficient: 3 % of specified accuracy / °C (<18 °C or >28 °C)

**Continuity Testing**

Tone	Resistance
Continuous tone	<25 Ω
May or may not get tone	25 to 400 Ω
No tone	>400 Ω

### Frequency Measurement

Ranges	Resolution	2 Year
1.00 Hz to 110.00 Hz <sup>[1]</sup>	0.01 Hz	0.05 Hz
110.1 Hz to 1100.0 Hz	0.1 Hz	0.5 Hz
1.101 kHz to 11.000 kHz	0.001 kHz	0.005 kHz
11.01 kHz to 50.00 kHz	0.01 kHz	0.05 kHz

Coupling: AC  
 Minimum Amplitude for Frequency Measurement (square wave):  
 <1 kHz: 300 mV p-p  
 1 kHz to 30 kHz: 1.4 V p-p  
 >30 kHz: 2.8 V p-p  
 Maximum input:  
 <1 kHz: 300 V rms  
 >1 kHz: 30 V rms  
 Input Impedance: >4 M $\Omega$   
 [1] For frequency measurement less than 110.00 Hz, specifications apply for signals with a slew rate >5 volt/millisecond.

### $\pm$ DC Voltage Output

Range	Resolution	% of Output + Floor	
		1-Year	2 Year
$\pm$ 100.000 mV	1 $\mu$ V	0.01 % + 0.005 mV	0.015 % + 0.005 mV
$\pm$ 1.00000 V	10 $\mu$ V	0.01 % + 0.00005 V	0.015 % + 0.00005 V
$\pm$ 15.0000 V	100 $\mu$ V	0.01 % + 0.0005 V	0.015 % + 0.0005 V

Maximum Output Current: 10 mA, In the 100 mV range add 0.010 mV to specification when sourcing >1 mA.  
 For sourcing dc voltages <110.000 mV, accuracy is not specified in RF fields >1 V/m, 80 MHz to 700 MHz.  
 Temperature Coefficient: 0.001 % of output + 0.001 % of range /  $^{\circ}$ C (<18  $^{\circ}$ C or >28  $^{\circ}$ C)

### +DC Current Source

Range/Mode	Resolution	% of Output + Floor	
		1-Year	2 Year
0.100 to 22.000 mA	1 $\mu$ A	0.01 % + 3 $\mu$ A	0.02 % + 3 $\mu$ A

Temperature Coefficient: 3 % of specified accuracy /  $^{\circ}$ C (<18  $^{\circ}$ C or >28  $^{\circ}$ C)  
 Source mA Compliance Voltage: 18 V maximum  
 Source mA Open Circuit Voltage: 30 V maximum

### +DC Current Simulate (External Loop Power)

Range/Mode	Resolution	% of Output + Floor	
		1-Year	2 Year
0.100 to 22.000 mA (Current Sink)	1 $\mu$ A	0.02 % + 7 $\mu$ A	0.04 % + 7 $\mu$ A

Simulate mA Input Voltage: 15 to 50 V dc, add 300  $\mu$ A to floor when >25 V is present on the loop  
 Temperature Coefficient: 3 % of specified accuracy /  $^{\circ}$ C (<18  $^{\circ}$ C or >28  $^{\circ}$ C)

### Resistance Sourcing

Range	Resolution	% of Output + Floor		Allowable Excitation Current
		1-Year	2 Year	
10.000 $\Omega$	0.001 $\Omega$	0.01 % + 0.010 $\Omega$	0.015 % + 0.015 $\Omega$	0.1 mA to 10 mA
100.00 $\Omega$ <sup>[1]</sup>	0.01 $\Omega$	0.01 % + 0.02 $\Omega$	0.015 % + 0.03 $\Omega$	0.1 mA to 10 mA
1.0000 k $\Omega$ <sup>[2]</sup>	0.1 $\Omega$	0.02 % + 0.0002 k $\Omega$	0.03 % + 0.0003 k $\Omega$	0.01 mA to 1.0 mA
10.000 k $\Omega$	1 $\Omega$	0.02 % + 0.003 k $\Omega$	0.03 % + 0.005 k $\Omega$	0.01 mA to 1.0 mA

Temperature Coefficient: (0.01 % of output + 0.02 % of range) /  $^{\circ}$ C (<18  $^{\circ}$ C or >28  $^{\circ}$ C).  
 When connected to mains, accuracy is not specified with conducted RF >1V, 8 to 15 MHz.  
 [1] Add 0.01  $\Omega$  when the excitation current is <1 mA.  
 [2] Add 0.0015 k $\Omega$  when the excitation current is <0.1 mA.

### Frequency Sourcing

Range	Specification
	2 Year
Sine Wave: 0.1 Hz to 10.99 Hz	0.01 Hz
Square Wave: 0.01 Hz to 10.99 Hz	0.01 Hz
Sine and Square Wave: 11.00 Hz to 109.99 Hz	0.1 Hz
Sine and Square Wave: 110.0 Hz to 1099.9 Hz	0.1 Hz
Sine and Square Wave: 1.100 kHz to 21.999 kHz	0.002 kHz
Sine and Square Wave: 22.000 kHz to 50.000 kHz	0.005 kHz
Waveform Choices: Zero-symmetric sine wave or positive 50 % duty-cycle square wave Square Wave Amplitude: 0.1 to 15 V p-p Square Wave Amplitude Accuracy, 0.01 to 1 kHz: 3 % p-p output + 75 mV, 1 kHz to 50 kHz: 10 % p-p output + 75 mV typical. Sine Wave Amplitude: 0.1 to 30 V p-p Sine Wave Amplitude Accuracy, 0.1 to 1 kHz: 3 % p-p output + 75 mV, 1 kHz to 50 kHz: 10 % p-p output + 75 mV typical. Frequency specifications are valid when averaged $\geq 100$ ms	

### Temperature, Thermocouples

Type	Range °C	Measure °C		Source °C	
		1-Year	2 Year	1-Year	2 Year
E	-250 to -200	1.3	2.0	0.6	0.9
	-200 to -100	0.5	0.8	0.3	0.4
	-100 to 600	0.3	0.4	0.3	0.4
	600 to 1000	0.4	0.6	0.2	0.3
N	-200 to -100	1.0	1.5	0.6	0.9
	-100 to 900	0.5	0.8	0.5	0.8
	900 to 1300	0.6	0.9	0.3	0.4
J	-210 to -100	0.6	0.9	0.3	0.4
	-100 to 800	0.3	0.4	0.2	0.3
	800 to 1200	0.5	0.8	0.3	0.3
K	-200 to -100	0.7	1.0	0.4	0.6
	-100 to 400	0.3	0.4	0.3	0.4
	400 to 1200	0.5	0.8	0.3	0.4
	1200 to 1372	0.7	1.0	0.3	0.4
T	-250 to -200	1.7	2.5	0.9	1.4
	-200 to 0	0.6	0.9	0.4	0.6
	0 to 400	0.3	0.4	0.3	0.4
B	600 to 800	1.3	2.0	1.0	1.5
	800 to 1000	1.0	1.5	0.8	1.2
	1000 to 1820	0.9	1.3	0.8	1.2
R	-20 to 0	2.3	2.8	1.2	1.8
	0 to 100	1.5	2.2	1.1	1.7
	100 to 1767	1.0	1.5	0.9	1.4
S	-20 to 0	2.3	2.8	1.2	1.8
	0 to 200	1.5	2.1	1.1	1.7
	200 to 1400	0.9	1.4	0.9	1.4
	1400 to 1767	1.1	1.7	1.0	1.5
C (W5Re/W26Re)	0 to 800	0.6	0.9	0.6	0.9
	800 to 1200	0.8	1.2	0.7	1.0
	1200 to 1800	1.1	1.6	0.9	1.4
	1800 to 2316	2.0	3.0	1.3	2.0
L	-200 to -100	0.6	0.9	0.3	0.4
	-100 to 800	0.3	0.4	0.2	0.3
	800 to 900	0.5	0.8	0.2	0.3
U	-200 to 0	0.6	0.9	0.4	0.6
	0 to 600	0.3	0.4	0.3	0.4

BP	0 to 1000	1.0	1.5	0.4	0.6
	1000 to 2000	1.6	2.4	0.6	0.9
	2000 to 2500	2.0	3.0	0.8	1.2
XK	-200 to 300	0.2	0.3	0.2	0.5
	300 to 800	0.4	0.6	0.3	0.6

Sensor inaccuracies not included.  
Accuracy with external cold junction; for internal junction add 0.2 °C  
Resolution: 0.1 °C  
Temperature Scale: ITS-90 or IPTS-68, selectable (90 is default)  
Compensation: ITS-90 per NIST Monograph 175 for B,R,S,E,J,K,N,T; IPTS-68 per IEC 584-1 for B,R,S,E,J,K,T; IPTS-68 per DIN 43710 for L,U. GOST P 8.585-2001 (Russia) for BP and XK, ASTM E988-96 for C (W5Re/W26Re)  
Temperature Coefficient: 0.05 °C/°C (<18 °C or >28 °C)  
0.07 °C/°C for C type >1800 °C and for BP type >2000 °C  
Instrument Operating Temperature: 0 to 50 °C for C and BP type thermocouples / -10 to 50 °C for all other types  
Normal Mode Rejection: 40 dB at 50 Hz or 60 Hz nominal  
For sourcing thermocouple voltages, accuracy is not specified in RF fields >1 V/m, 80 MHz to 700 MHz.

### Temperature, Resistance Temperature Detectors

Temperature, RTDs Degrees or % of Reading <sup>[1]</sup>							
Type (α)	Range °C	Measure °C <sup>[2]</sup>			Source °C		Allowable Excitation Current <sup>[3]</sup>
		1-Year	2 Year	Source Current	1-Year	2 Year	
100 Ω Pt(385)	-200 to 100	0.07 °C	0.14 °C	1 mA	0.05 °C	0.10 °C	0.1 to 10 mA
	100 to 800	0.02 % + 0.05 °C	0.04 % + 0.10 °C		0.0125 % + 0.04 °C	0.025 % + 0.08 °C	
200 Ω Pt(385)	-200 to 100	0.07 °C	0.14 °C	500 μA	0.10 °C	0.20 °C	0.1 to 1 mA
	100 to 630	0.02 % + 0.05 °C	0.04 % + 0.10 °C		0.017 % + 0.09 °C	0.034 % + 0.18 °C	
500 Ω Pt(385)	-200 to 100	0.07 °C	0.14 °C	250 μA	0.08 °C	0.16 °C	0.1 to 1 mA
	100 to 630	0.02 % + 0.05 °C	0.04 % + 0.10 °C		0.017 % + 0.06 °C	0.034 % + 0.12 °C	
1000 Ω Pt(385)	-200 to 100	0.07 °C	0.14 °C	150 μA	0.06 °C	0.12 °C	0.1 to 1 mA
	100 to 630	0.02 % + 0.05 °C	0.04 % + 0.10 °C		0.017 % + 0.05 °C	0.034 % + 0.10 °C	
100 Ω Pt(3916)	-200 to 100	0.07 °C	0.14 °C	1 mA	0.05 °C	0.10 °C	0.1 to 10 mA
	100 to 630	0.02 % + 0.05 °C	0.04 % + 0.10 °C		0.0125 % + 0.04 °C	0.025 % + 0.08 °C	
100 Ω Pt(3926)	-200 to 100	0.08 °C	0.16 °C	1 mA	0.05 °C	0.10 °C	0.1 to 10 mA
	100 to 630	0.02 % + 0.06 °C	0.04 % + 0.12 °C		0.0125 % + 0.04 °C	0.025 % + 0.08 °C	
10 Ω Cu(427)	-100 to 260	0.2 °C	0.4 °C	3 mA	0.2 °C	0.4 °C	1 to 10 mA
120 Ω Ni(672)	-80 to 260	0.1 °C	0.2 °C	1 mA	0.04 °C	0.08 °C	0.1 to 10 mA

[1] Specifications are valid to k=3  
Sensor inaccuracies not included  
[2] For two and three-wire RTD measurements, add 0.4 °C to the specifications.  
Resolution: 0.01 °C except 0.1 °C for 10 Ω Cu(427)  
Temperature Coefficient: 0.01 °C/°C for measure, 0.02 °C/°C (<18 °C or >28 °C) for source  
[3] Supports pulsed transmitters and PLCs with pulse times as short as 1 ms  
RTD Reference:  
Pt(385): IEC 60751, 2008  
Pt(3916): JIS C 1604, 1981  
Pt(3926), Cu(427), Ni(672): Minco Application Aid #18

### Loop Power

Open Circuit	Loaded Circuit
26 V ±10 %	18 V minimum at 22 mA
Short circuit protected to 25 mA Output Resistance: 250 Ω nominal	



## Performance Verification Tests

Fluke recommends re-certification each year. To re-certify, do the verification procedure. If test points are out of tolerance, calibrate the Product and then re-verify. Two-year specifications are included if the highest accuracy is not necessary.

Use the subsequent tests to make sure that the Product is inside its specification limits.

## Verification Equipment

The equipment necessary for verification of the Product is shown in Table 2. If these instruments are not available, you can replace them with other source and measure instruments that have the same the minimum specification requirements.

**Table 2. Equipment Required for Verification**

Equipment	Minimum Specification	Recommended Model
Calibrator	0.002 % for DC Voltage, Resistance and Current. 0.01 % for AC Volt	Fluke 5522A
Frequency Counter	1 Hz to 50 kHz, 25 ppm timebase	Tektronix FCA3000
Oscilloscope	1 Hz to 50 kHz (duty cycle accuracy 1 %)	Fluke 123
DMM	0.002 % for DC Voltage, Resistance and Current	Fluke 8508A
2-Short jumpers	banana type	Fluke PN 944632
2-Test leads	banana to banana type	Fluke TL20
Thermocouple miniplug	polarize, with type-K thermocouple welded to copper wire	see Figure 10
Lag bath	characterized by a 0.1 °C standard thermometer (0.02 °C resolution) and a 1-pint thermos bottle	Fluke 1551A Stik Thermometer, Dewar Flask and Cap
Smart (HART) Pressure Transmitter	HART communication protocol	Rosemount 1151 or 3051
HART Interface Cable Assembly		Fluke PN 3562160

### How to Verify

For each procedure there is a table of test points and permitted readings. If the result of the test is not in the range shown, the Unit Under Test (UUT) is out of tolerance and must be re-calibrated or repaired if necessary. There are columns for 1 and 2-year specifications wherever the specifications are different.

Follow these general instructions for all the tests:

- For all tests, operate the UUT on battery power. Make sure the battery is fully charged.
- For measurement functions, push the **Range** softkey to lock the range on the range specified in the test points table. It can be necessary to push the **Range** softkey more than once.
- Ranges in the specification tables include the 10 % over-range capability. Range names on the Product display do not include the 10 % over-range. For example, the UUT display shows Range 100 mV, but the range is specified to 110 mV.
- Let each piece of verification equipment have its specified warm-up time.
- A minimum of 5 minutes is necessary for warm up. The source circuits shut off when not in operation. A separate warm up is necessary when Source mode is first used.
- For each test, make sure the verification equipment is stable and that the “unsettled” annunciator on the UUT is not shown.

### DC Volts Measurement

To verify the dc volts measurement function:

1. Connect the UUT to the 5522A as shown in Figure 1.

#### **Caution**

**To prevent possible damage to the Product, do not force a dual banana plug between any two jacks in the horizontal orientation. Doing so will damage the jacks. Use the supplied jumper wire when needed for RTD measurements. A dual banana plug may be used in the vertical orientation.**

2. Set the UUT to the dc volts measurement function.
3. Push the **Range** softkey on the UUT to lock on the 100 mV range.
4. Set the 5522A to the first test point in Table 3.
5. See if the value shown on the UUT is in the range shown in the applicable column.
6. Continue through the test points. Make sure to lock the UUT on the specified range.
7. When you complete the test, set the 5522A to STANDBY.

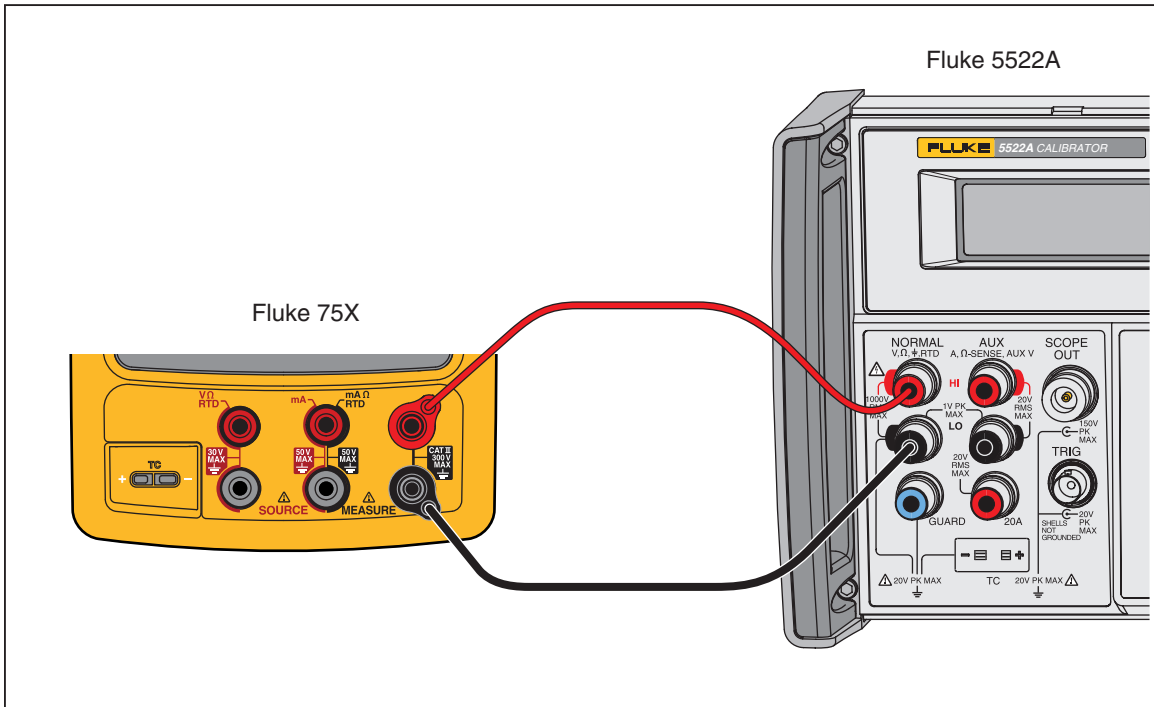

Figure 1. DC Volts and AC Volts Measurement Connections

gso03.eps

Table 3. DC Volts Measurement Verification Points

UUT Range	Input V dc	Minimum 1-Year	Maximum 1-Year	Minimum 2-Year	Maximum 2-Year
100.000 mV	0	-0.005	0.005	-0.005	0.005
100.000 mV	0.1	99.975	100.025	99.965	100.035
100.000 mV	-0.1	-100.025	-99.975	-100.035	-99.965
3.00000 V	0	-0.00005	0.00005	-0.00005	0.00005
3.00000 V	1.0	0.99975	1.00025	0.99965	1.00035
3.00000 V	2.0	1.99955	2.00045	1.99935	2.00065
3.00000 V	3	2.99935	3.00065	2.99905	3.00095
3.00000 V	-3	-3.00065	-2.99935	-3.00095	-2.99905
30.0000 V	0	-0.0005	0.0005	-0.0005	0.0005
30.0000 V	30	29.9935	29.9870	29.9905	30.0095
30.0000 V	-30	-30.0065	-29.9935	-30.0095	-29.9905
300.00 V	0	-0.05	0.05	-0.05	0.05
300.00 V	295	294.80	295.20	294.74	295.26
300.00 V	-295	-295.20	-294.80	-295.26	-294.74

### AC Volts Measurement

To verify the ac volts measurement function:

1. Connect the UUT to the 5522A as shown in Figure 1.
2. Set the UUT to the ac volts measurement function.
3. Push the **Range** softkey on the UUT to lock on the 3.0 V range.
4. Set the 5522A to the first test point in Table 4.
5. Stop to let the output become stable.
6. See if the value shown on the UUT is in the range shown in the applicable column.
7. Continue through the test points. Make sure to lock the UUT on the specified range.
8. When you complete the test, set the 5522A to STANDBY.

**Table 4. AC Volts Measurement Verification Points**

UUT Range	Input (RMS)	Frequency	Minimum 1-Year	Maximum 1-Year	Minimum 2-Year	Maximum 2-Year
3.000 V	0.26	500 Hz	0.257	0.263	0.253	0.267
3.000 V	3	500 Hz	2.983	3.017	2.966	3.034
3.000 V	0.26	40 Hz	0.257	0.263	0.253	0.267
3.000 V	3	40 Hz	2.983	3.017	2.966	3.034
30.00 V	2.6	500 Hz	2.567	2.633	2.53	2.67
30.00 V	30	500 Hz	29.830	30.170	29.66	30.34
30.00 V	2.6	40 Hz	2.567	2.633	2.53	2.67
30.00 V	30	40 Hz	29.830	30.170	29.66	30.34
300.0 V	27	500 Hz	26.665	27.335	26.5	27.5
300.0 V	295	500 Hz	293.325	296.675	291.9	298.2
300.0 V	27	40 Hz	26.665	27.335	26.5	27.5
300.0 V	295	50 Hz	293.325	296.675	291.9	298.2

### DC Current Measurement

To verify the dc current measurement function:

1. Connect the UUT to the 5522A and the 8508A as shown in Figure 2.
2. Disconnect the jumpers on the three common jacks (lows) of the UUT if they are present.
3. Set the UUT and the 8508A to the dc current measurement function and the 5522A to source dc current.
4. Push the **Range** softkey on the UUT to lock on the 30 mA range.
5. Set the 5522A to the first test point in Table 5, and edit its output so that the correct value shows on the 8508A.
6. See if the value shown on the UUT is in the range shown in the applicable column.
7. Continue through the test points. Make sure to lock the UUT on the specified range.
8. When you complete the test, set the 5522A to STANDBY.

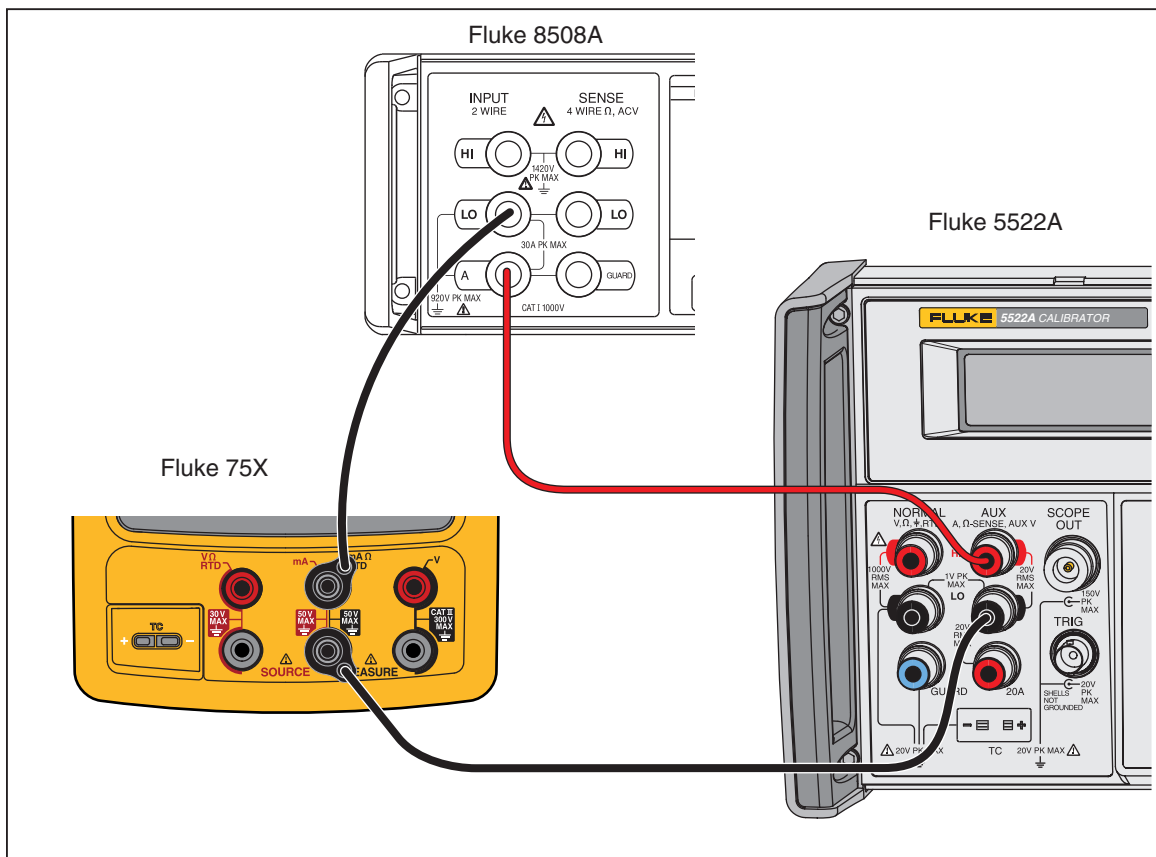

Figure 2. DC Current Measurement Verification Connections

gso04.eps

Table 5. DC Current Measurement Verification Points

UUT Range	Input mA	Minimum 1-Year	Maximum 1-Year	Minimum 2-Year	Maximum 2-Year
30 mA	4 mA	3.995	4.005	3.992	4.008
30 mA	20 mA	19.993	20.007	19.990	20.010
30 mA	30 mA	29.992	30.008	29.989	30.012
30 mA	-30 mA	-30.008	-29.992	-30.012	-29.989
100 mA	0 mA	-0.02	0.02	-0.03	0.03
100 mA	100 mA	99.97	100.03	99.96	100.04
100 mA	-100 mA	-100.03	-99.97	-100.04	-99.96

### Resistance Measurement

To verify the resistance measurement function:

1. Connect the UUT to the 5522A as shown in Figure 3.
2. Use a four-wire connection at the 5522A, transitioning to two wires at the UUT, and turn on Two-Wire Compensation.
3. Set the UUT to the resistance measurement function.
4. Push the **Range** softkey on the UUT to lock on the 10  $\Omega$  range.
5. Set the 5522A to the first test point in Table 6.
6. See if the value shown on the UUT is in the range shown in the applicable column.
7. Continue through the test points. Make sure to lock the UUT on the specified range.
8. When you complete the test, set the 5522A to STANDBY.

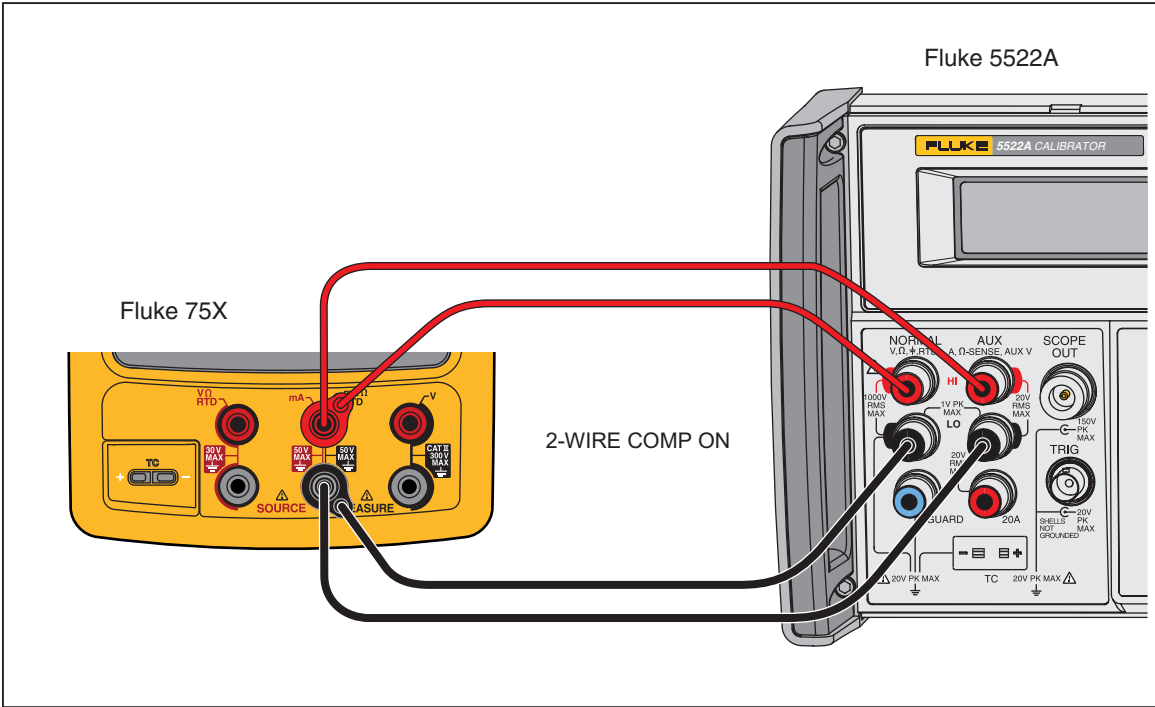

Figure 3. Resistance Measurement Verification Connections

gso05.eps

Table 6. Resistance Measurement Verification Points

UUT Range	Input	Minimum 1-Year	Maximum 1-Year	Minimum 2-Year	Maximum 2-Year
10.000 Ω	0 Ω	-0.050	0.050	-0.070	0.070
10.000 Ω	10 Ω	9.945	10.055	9.923	10.077
100.00 Ω	0 Ω	-0.05	0.05	-0.07	0.07
100.00 Ω	100 Ω	99.90	100.10	99.86	100.14
1000.0 Ω	0 Ω	-0.5	0.5	-0.7	0.7
1000.0 Ω	1 kΩ	999.0	1001.0	998.6	1001.4
10.000 kΩ	0 Ω	-0.010	0.010	-0.015	0.015
10.000 kΩ	10 kΩ	9.980	10.020	9.970	10.030

### Frequency Measurement

To verify the frequency measurement function:

1. Connect the UUT as shown in Figure 4 .
2. Set the UUT to the frequency measurement function.
3. Select the <20 Hz range for the first step. Use the  $\geq 20$  Hz range thereafter.
4. Set the 5522A to the first test point in Table 7.
5. See if the frequency value shown on the UUT is in the range shown in the applicable column.
6. Continue through the test points.
7. When you complete the test, set the 5522A to STANDBY.

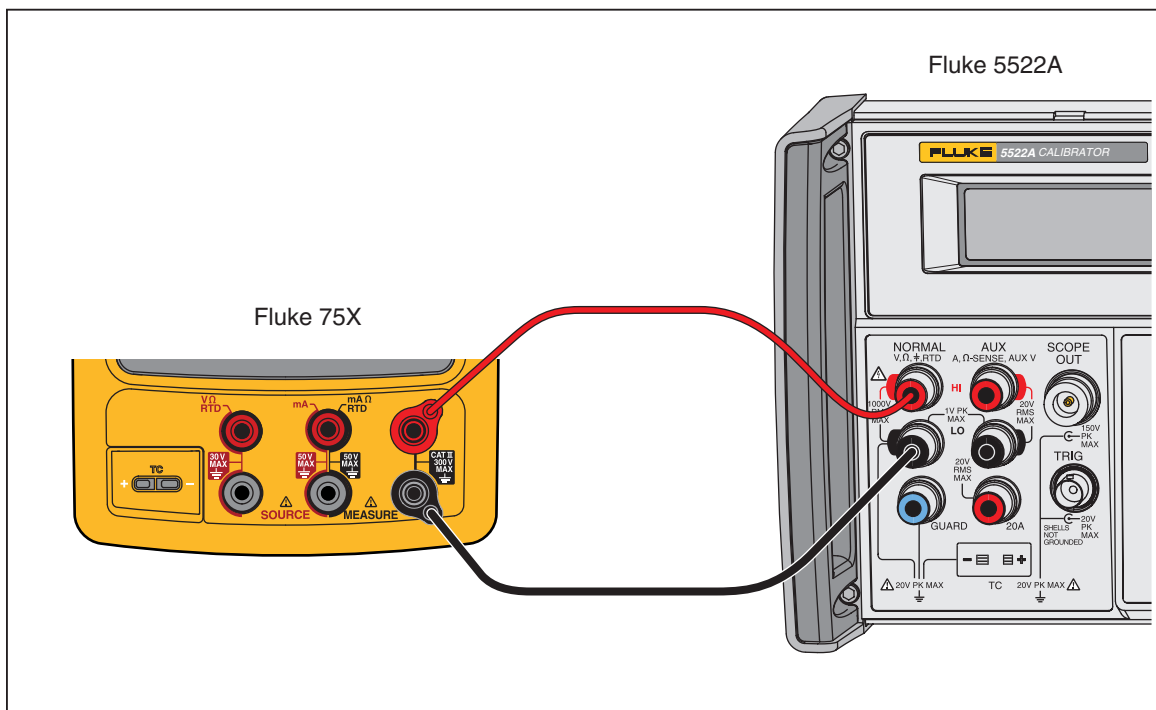

Figure 4. Frequency Measurement Verification Connections

gso06.eps

Table 7. Frequency Measurement Verification Points

UUT Range	Frequency Input	V RMS	Minimum 1- & 2-Year	Maximum 1- & 2-Year
<20 Hz	10 Hz	300 mV	9.95	10.05
>20 Hz	150 Hz	300 mV	149.5	150.5
>20 Hz	1.2 kHz	1.0 V	1.195	1.205
>20 Hz	12 kHz	1.0 V	11.95	12.05
>20 Hz	49 kHz	2.0 V	48.95	49.05



**DC Volts Source**

To verify the dc volts source function:

1. Connect the UUT to the 8508A as shown in Figure 5.
2. Set the 8508A to measure dc volts.
3. Set the UUT to the dc volts source function at -10 mV. Let the UUT warm up for a minimum of 5 minutes before you read the first indication.
4. See if the value shown on the 8508A is in the range shown in the applicable column in Table 8.
5. Continue through the test points. See if the value shown on the UUT is in the range shown in the applicable column.
6. When you complete the test, push CLEAR  
(ZERO) on the UUT two times to turn the source function off. This conserves battery life.

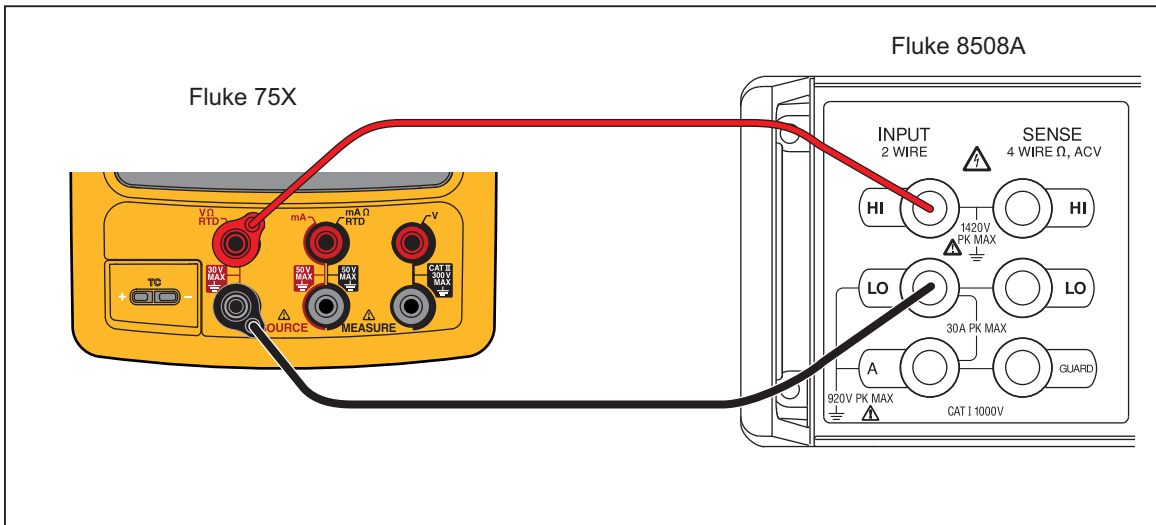

**Figure 5. DC Volts Source Verification Connections**

gso07.eps

**Table 8. DC Volts Source Verification Points**

UUT Range	UUT Output	Minimum 1-Year	Maximum 1-Year	Minimum 2-Year	Maximum 2-Year
100.000	10 mV	9.9940	10.0060	9.9935	10.0065
100.000	0.1 V	99.9850	100.0150	99.9800	100.0200
1.00000 V	0.15 V	0.14994	0.15007	0.14993	0.15007
1.00000 V	1 V	0.99985	1.00015	0.99980	1.00020
15.0000 V	1.5 V	1.49935	1.50065	1.49928	1.50073
15.0000 V	10 V	9.99850	10.00150	9.99800	10.00200

### DC Current Source

To verify the dc current source function.

1. Connect the UUT to the 8508A as shown in Figure 6.
2. Set the 8508A to DC Current.
3. Set the UUT to dc current source (not simulate transmitter) function at 2 mA.
4. See if the value shown on the 8508A is in the range shown in the applicable column in Table 9.
5. Continue through the test points. See if the value shown on the UUT is in the range shown in the applicable column.
6. When you complete the test, push **CLEAR (ZERO)** on the UUT two times to turn off the source function. This conserves battery life.

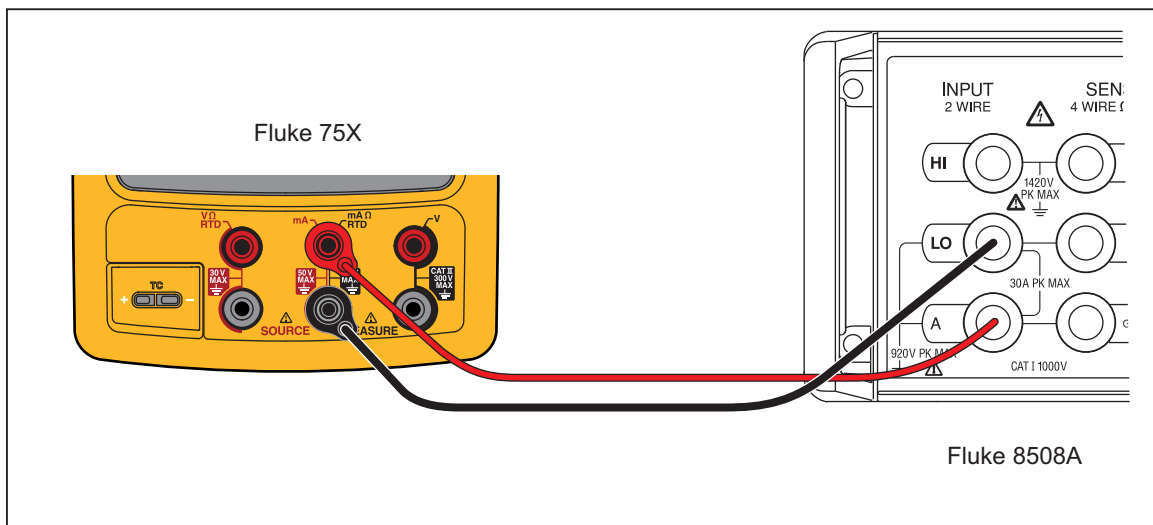

Figure 6. DC Current Source Verification Connections

gso08.eps

Table 9. DC Current Source Verification Points

UUT Range	UUT Output	Minimum 1-Year	Maximum 1-Year	Minimum 2-Year	Maximum 2-Year
22.000 mA	2 mA	1.99680	2.00320	1.99660	2.00340
22.000 mA	4 mA	3.99660	4.00340	3.99620	4.00380
22.000 mA	12 mA	11.99580	12.00420	11.99460	12.00540
22.000 mA	21 mA	20.99490	21.00510	20.99280	21.00720

**Simulate Transmitter Function**

To verify the simulate transmitter function (accessed through dc current source function):

1. Connect the UUT, 8508A, and 5522A as shown in Figure 7. The 5522A is used as a stable dc voltage source. Its value is not critical, and a different dc source such as a battery can be used if necessary.
2. Set the 8508A to DC Current .
3. Set the UUT to the [mA Source] function and then select Simulate Transmitter.
4. Set the UUT source value to 4 mA.
5. Set the 5522A to output 8 V dc.
6. See if the value shown on the 8508A is in the range shown in Table 10.
7. Change the UUT source value to 22 mA and examine the results again in Table 10.
8. When you complete the test, set the 5522A to STANDBY and push **CLEAR (ZERO)** on the UUT two times to turn the source function off. This conserves battery life.

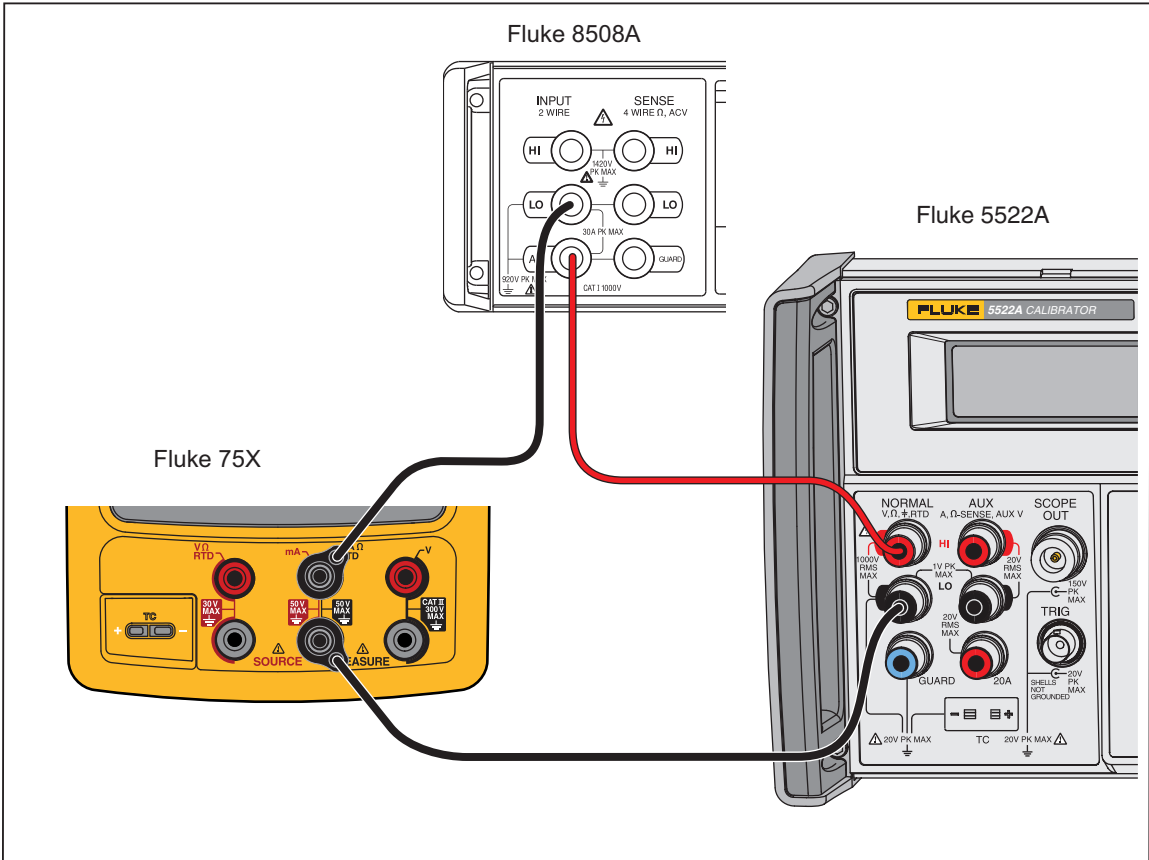

Figure 7. Simulate Transmitter Verification Connections

gso09.eps

Table 10. Simulate Transmitter Verification Points

UUT Range	UUT Output	Minimum 1-Year	Maximum 1-Year	Minimum 2-Year	Maximum 2-Year
22.000 mA	4	3.99220	4.00780	3.99140	4.00860
22.000 mA	21	20.98880	21.01120	20.98460	21.01540

**Resistance Source Function**

To verify the resistance source function:

1. Connect the UUT to the 8508A as shown in Figure 8. Use a four-wire connection transitioning to two wires at the UUT.
2. Set the UUT to the resistance source function at 0.1  $\Omega$ .
3. On the 8508A, select four-wire ohms measurement and up-range to the 200  $\Omega$  range. Use the 200  $\Omega$  range for the first five tests points, and autorange thereafter. The low range of the 8508A supplies too much current into the UUT.
4. See if the value shown on the 8508A is in the range shown in Table 11.
5. Continue through the test points. See if the value shown on the UUT is in the range shown in the applicable column of Table 11.
6. When you complete the test, push  on the UUT two times to turn off the source function. This conserves battery life.

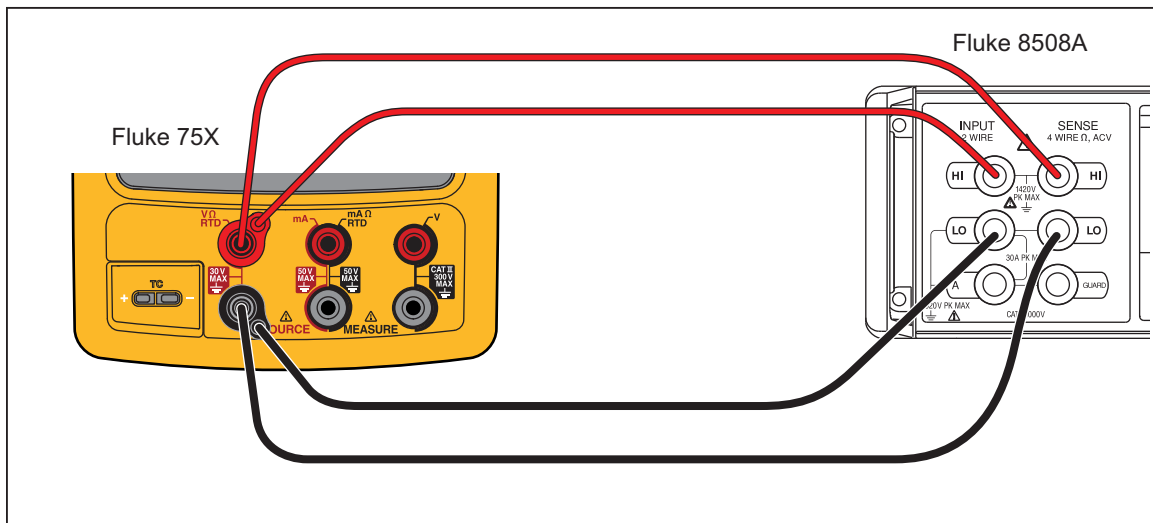

Figure 8. Resistance Source Verification Connections

gso10.eps

**Table 11. Resistance Source Verification Points**

UUT Range	UUT Output	Minimum 1-Year	Maximum 1-Year	Minimum 2-Year	Maximum 2-Year
10.000 Ω	0.1 Ω	0.0900	0.1100	0.0850	0.1150
10.000 Ω	1 Ω	0.9899	1.0101	0.9849	1.0152
10.000 Ω	10 Ω	9.9890	10.0110	9.9835	10.0165
100.00 Ω	20 Ω	19.978	20.022	19.967	20.033
100.00 Ω	100 Ω	99.970	100.030	99.955	100.045
1000.0 Ω	200 Ω	199.76	200.24	199.64	200.36
1000.0 Ω	1000 Ω	999.60	1000.40	999.40	1000.60
10.000 kΩ	2 kΩ	1.9966	2.0034	1.9944	2.0056
10.000 kΩ	10 kΩ	9.9950	10.0050	9.9920	10.0080

### Frequency Source

To verify the frequency source function:

1. Connect the UUT to the Tektronix FCA3000 Counter as shown in Figure 9.
2. Set the UUT to source, frequency, 1.000 Vpp, square wave, at 5 Hz.
3. See if the value shown on the Tektronix FCA3000 is in the range shown in the applicable column in Table 11
4. Use the Fluke 123 to examine the wave forms. For the square wave, a positive square wave, with a 50 % duty-cycle ( $\pm 5\%$ ), and 1.0 V peak amplitude. See that the amplitude is correct for the applied signal. For the sine wave, make sure you have the correct frequency, waveform, and amplitude.
5. Continue through the test points. See if the value shown on the UUT is in the range shown in the applicable column of Table 12.
6. When you complete the test, push CLEAR  
(ZERO) on the UUT two times to turn off the source function. This conserves battery life.

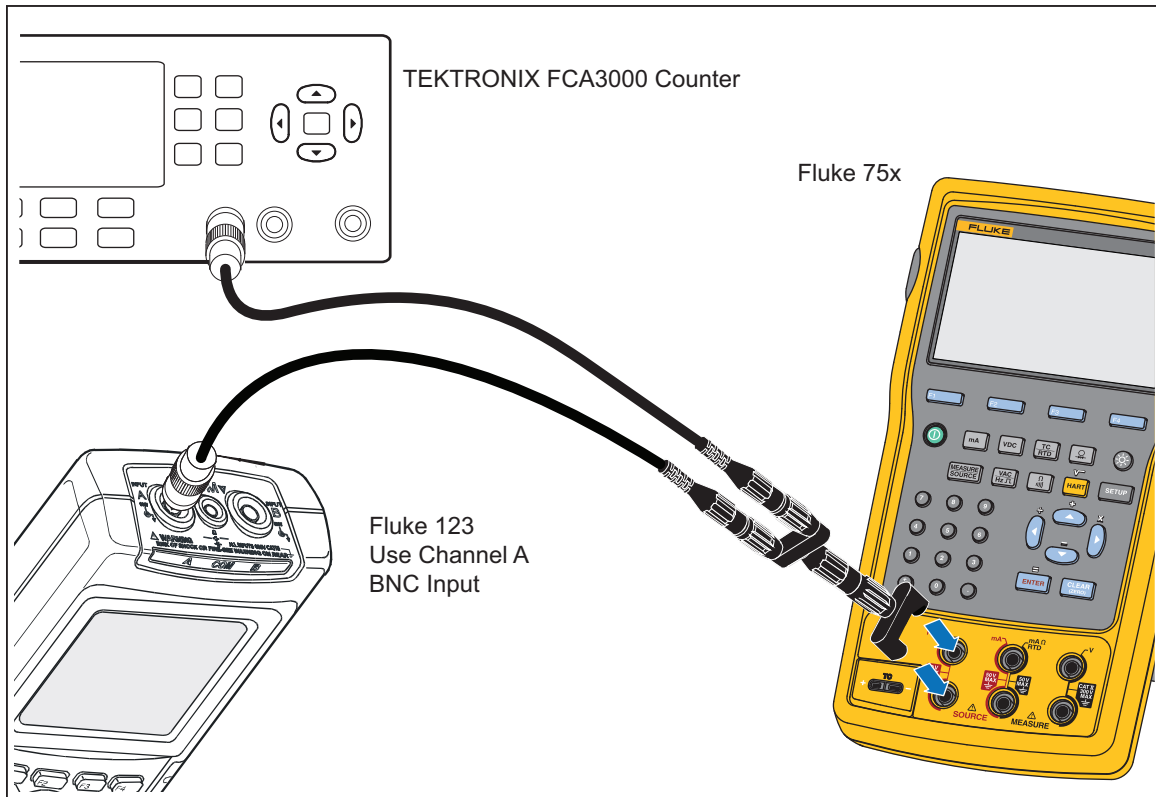

gso11.eps

Figure 9. Frequency Source Verification Connections

Table 12. Frequency Source Verification Points

UUT Range	Frequency @ 1 Vpp	Minimum Frequency	Maximum Frequency
10.99 Hz	5 Hz Sine	4.99 Hz	5.01 Hz
1099.9 Hz	1 kHz Sine	999.9 Hz	1000.1 Hz
21.999 kHz	10 kHz Sine	9.998 kHz	10.002 kHz
50 kHz	49 kHz Sine	48.995 kHz	49.005 kHz
10.99 Hz	5 Hz Square	4.99 Hz	5.01 Hz
1099.9 Hz	1 kHz Square	999.9 Hz	1000.1 Hz
UUT Range	Frequency @ 7.5 Vpp	Minimum Frequency	Maximum Frequency
109.99 Hz	50 Hz Square	49.9 Hz	50.1 Hz

### **Thermocouple Measure**

To verify the thermocouple measure function.

1. Use Type-K thermocouple wire and copper wire to connect the 5522A output to the UUT-TC jack as shown in Figure 10. The Type K-to-Copper junctions must be welded or made with tight screw terminals and submersed in the lag bath (room temperature). Use the standard thermometer (0.1 °C accuracy) to measure the temperature of the lag bath.
2. Set the 5522A to source dc millivolts and the UUT to the thermocouple measure function, TC Type K; ITS-90 scale, internal reference, and °C.
3. Stop for a minimum of 1 minute for thermal “emfs” (caused by insertion of the connectors) to dissipate, and let the lag bath become stable for a minimum of 15 minutes.
4. Use the 5522A to source the millivolt equivalents of the temperatures in Table 13. At each point, correct the 5522A output voltage. To do this, subtract the millivolt equivalent of the temperature at the lag bath junction (use reference chart below).
5. Continue through the test points. See if the value shown on the UUT is in the range shown in the applicable column of Table 13.
6. When you complete the test, set the 5522A to STANDBY.

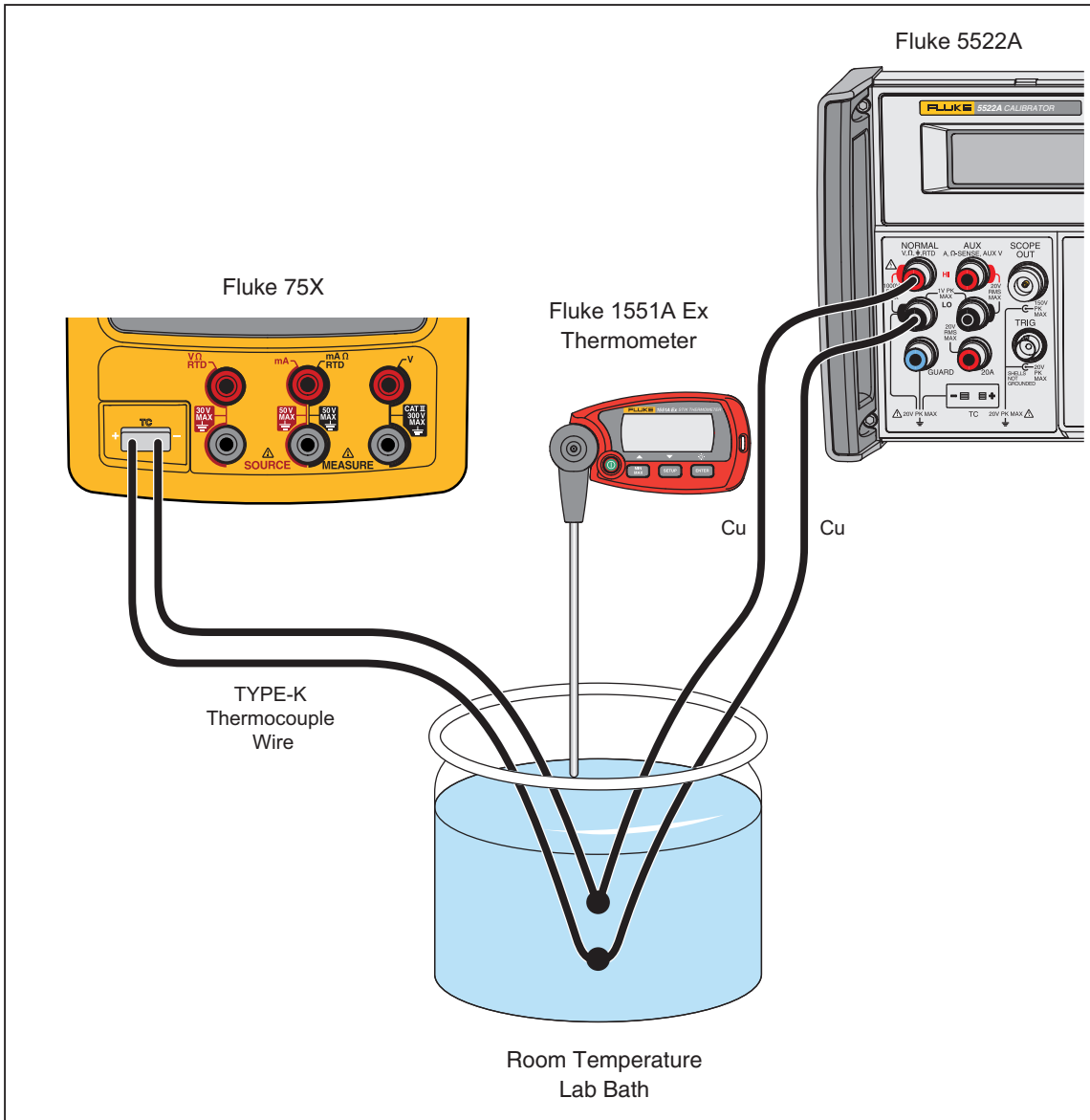

Figure 10. Temperature Measure (TC) Verification Connections

gs012.eps



**Table 13. Temperature Measure Verification**

Input dcmV (referenced to 0 °C)	Minimum 1-Year °C	Maximum 1-Year °C	Minimum 2-Year °C	Maximum 2-Year °C							
-5.550 mV (-180 °C)	-180.9	-179.1	-181.2	-178.8							
0.000 mV (0 °C)	-0.5	0.5	-0.6	0.6							
52.410 mV (1300 °C)	1299.1	1300.9	1298.8	1301.2							
<b>Lag Bath Reference Table, Type K, ITS-90</b>											
Temp. °C	18	19	20	21	22	23	24	25	26	27	28
mV	0.718	0.758	0.798	0.838	0.879	0.919	0.960	1.000	1.041	1.081	1.122

**Thermocouple Source**

To verify the thermocouple source function:

*Note*

*This test uses a Type-K thermocouple setting on the UUT.*

1. Use Type-K thermocouple wire and copper wire to connect the 8508A to the UUT -TC jack as shown in Figure 10 (the 8508A is used in place of the 5522A). The type K-to-copper junctions must be welded or made with tight screw terminals and submersed in the lag bath (room temperature). Use the standard thermometer (0.1 % accuracy) to measure the temperature of the lag bath.
2. Set the UUT to the thermocouple source function, linear mode, TC type K, ITS-90 scale, internal reference, and °C.
3. Set the 8508A to measure mV dc.
4. Stop for a minimum of 1 minute for thermal “emfs” (caused by insertion of the connectors) to dissipate, and let the lag bath become stable for a minimum of 15 minutes.
5. Source each of the temperatures in Table 14 from the UUT. At each point, correct the DMM measured voltage. To do this, add the millivolt equivalent of the Type-K junction at the lag bath temperature (use the Type-K ITS-90 chart).
6. Continue through the test points. See if the value shown on the UUT is in the range shown in the applicable column in Table 14.
7. When you complete the test, push CLEAR  
(ZERO) on the UUT two times to turn the source function off. This conserves battery life.

**Table 14. Temperature Source Verification (Type-K Thermocouple, ITS-90)**

UUT Output	Nominal DC mV	Minimum 1-Year	Maximum 1-Year	Minimum 2-Year	Maximum 2-Year
-180 °C	-5.5504	-5.5616	-5.539	-5.5653	-5.5353
0 °C	0.0000	-0.0197	0.0197	-0.0237	0.0237
1300 °C	52.4103	52.3928	52.4277	52.3893	52.4312

*RTD Measure, Four-Wire*

*Note*

*It is necessary to use a separate verification procedure for the three-wire RTD measure function because it uses different circuits. The two-wire RTD measure circuit is tested during the Ohms Measure procedure. If a 5522A is not available, replace it with a variable resistance source such as a general resistance RTD-100 RTD simulator and a DMM to measure the variable resistance source for accuracy. Use the resistance equivalents shown in Table 15.*

To verify the four-wire RTD Measure function:

1. Connect the UUT to the 5522A as shown in Figure 11. Use a four-wire connection and four-wire compensation.
2. Set the UUT to the RTD measure function, Pt100 (385), ITS-90 scale, and four-wire termination.
3. Set the 5522A to RTD, Pt100 (385) at -180 °C, ITS-90 scale, and comp four-wire.
4. Set the 5522A to [Operate].
5. See if the value shown on the UUT is in the range shown in the applicable column in Table 15.
6. Continue through the test points.
7. When you complete the test, set the 5522A to STANDBY.

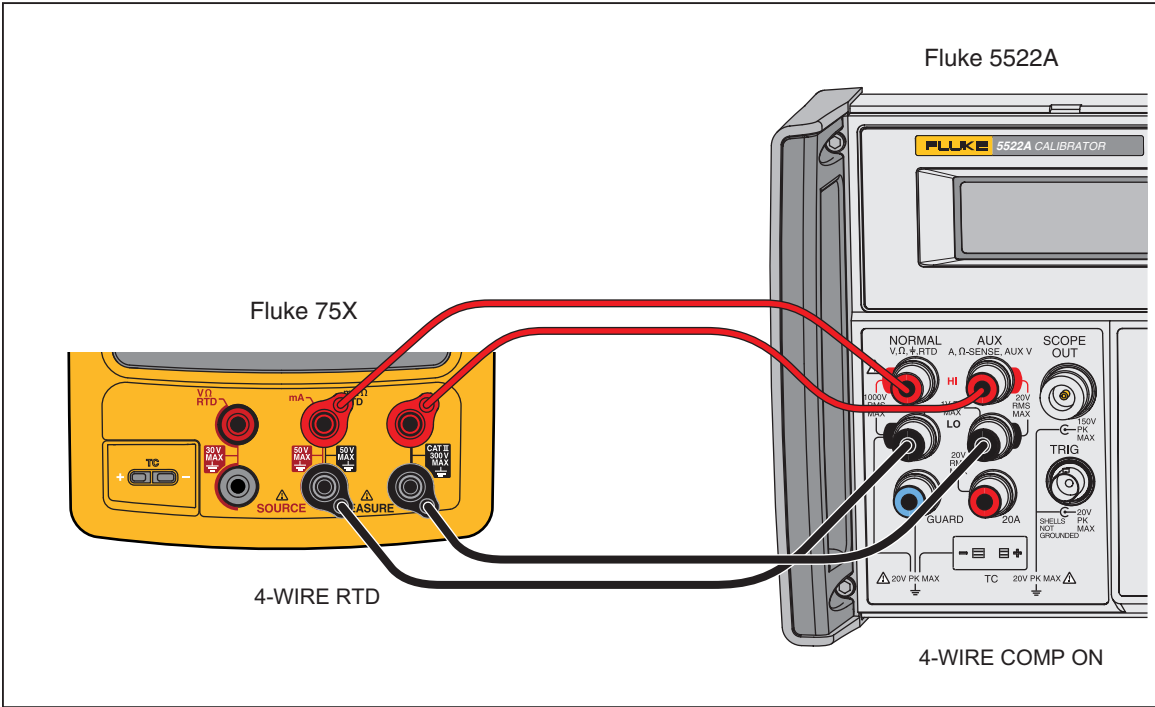

**Figure 11. Four-Wire RTD Measure Verification Connections**

gso13.eps

**Table 15. RTD Measure Verification (100W Pt (385), Four-Wire Connection)**

Input °C (Resistance)	1-Year ( °C )	2-Year ( °C )
-180 ° (27.096 Ω)	-179.93 to -180.07	-179.86 to -180.14
100 ° (138.505 Ω)	99.93 to 100.07	99.86 to 100.14
780 ° (369.712 Ω)	779.79 to 780.21	779.59 to 780.41

**RTD Measure, Three-Wire**

*Note*

*If a 5522A is not available, substitute a variable resistance source such as a General Resistance RTD-100 RTD Simulator and a DMM to measure the variable resistance source accurately. Use the resistance equivalents shown in Table 16.*

To verify the three-wire RTD measure function:

1. Connect the UUT to the 5522A as shown in Figure 12.
2. Set the UUT to the RTD measure function, Pt100 (385), ITS-90 scale, three-wire termination.
3. Set the 5522A to RTD, Pt100 (385) at -180 °C, ITS-90 scale, and comp four-wire to “OFF” position.
4. Set the 5522A to [Operate].
5. See if the value shown on the UUT is in the range shown in the applicable column in Table 16.

6. Continue through the test points.
7. When you complete the test, set the 5522A to STANDBY.

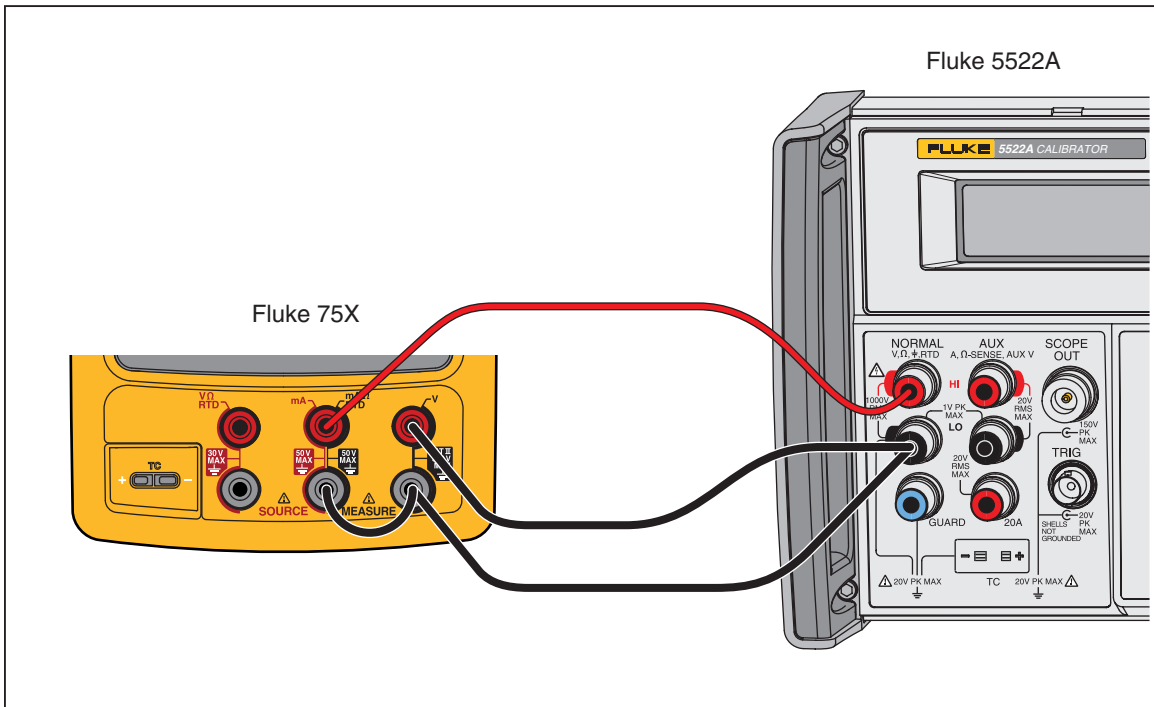

Figure 12. Three-Wire RTD Measure Verification Connections

gso14.eps

Table 16. RTD Measure Verification (100W Pt (385), Three-Wire Connection)

Input °C (Resistance)	1-Year ( °C )	2-Year ( °C )
-180 ° (27.096 Ω)	-179.53 to -180.47	-179.46 to -180.54
100 ° (138.505 Ω)	99.53 to 100.47	99.46 to 100.54
780 ° (369.712 Ω)	779.39 to 780.61	779.19 to 780.81

**RTD Source**

To verify the RTD Source function:

1. Connect the UUT to the 8508A DMM as shown in Figure 8. Use a four-wire connection transitioning to two-wires at the UUT.
2. Set the 8508A to 4-Wire Ohms, auto-range.
3. Set the UUT to the RTD source function, Pt100 (385) at -180 °C, ITS-90 scale.
4. See if the value shown on the DMM is in the range shown in the applicable column in Table 17.
5. Continue through the test points.
6. When you complete the test, push CLEAR  
(ZERO) on the UUT two times to turn the source function off. This conserves battery life.

**Table 17. RTD Source Verification (100W Pt (385))**

UUT Output	Nominal (Ohms)	Minimum 1-Year	Maximum 1-Year	Minimum 2-Year	Maximum 2-Year
-180 °C	27.096	27.075	27.118	27.054	27.139
100 °C	138.505	138.487	138.524	138.468	138.543
780 °C	369.712	369.6707	369.7532	369.630	369.795

### Loop Power

To verify the loop power function.

1. Connect the UUT to the 8508A DMM as shown in Figure 13.
2. On the UUT push **SETUP**, **ENTER**, select Loop Power, and push **ENTER** again.
3. Observe the no-load voltage reading on the DMM and verify that it is within the range 23.4 V to 28.6 V.
4. When complete, disable Loop Power through the setup menu or turn the UUT off. This conserves battery life.

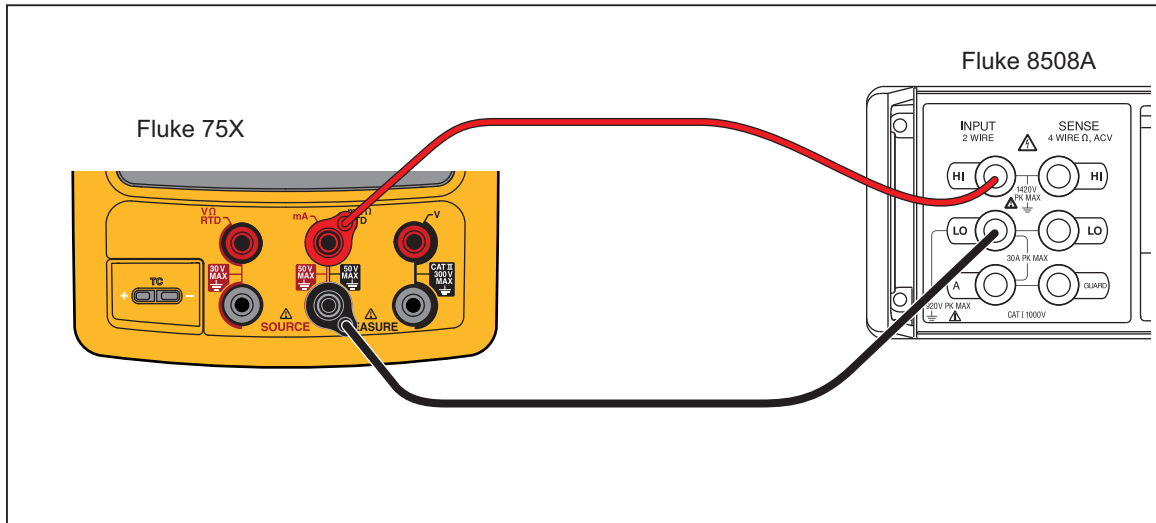

Figure 13. Loop Power Verification Connections

gso15.eps

### HART Mode Verification (754 Only)

The subsequent test makes sure that the 754 can communicate over a serial HART® (Highway Addressable Remote Transducer) interface to a HART transmitter. The calibrator communicates with virtually all HART transmitters and related software versions. These are “supported transmitters”. All other transmitters are “generic”. A Smart (HART) Pressure Transmitter is necessary for this procedure. The Rosemount Models 1151 or 3051 are recommended (may be substituted with any HART communicator protocol device).

This verification test is a pass or fail test. No calibration is necessary for the HART mode. If the Product fails this test, repair is necessary. Refer to the *754 HART Mode Users Guide* for more data on the HART feature.

It is not necessary to open the case or adjust the Product to do this test. Make the necessary connections and verify that the Product responds as necessary.

1. Push **SETUP**. The first setup screen shows.
2. Push **▲** or **▼** to select HART Channel.
3. Push **ENTER**.
4. Push **▲** or **▼** to select mA Jack.
5. Push **ENTER**.
6. Connect the Product to the HART transmitter as shown in Figure 15.
7. Push **HART** to start HART mode. If necessary, push the applicable softkey to enable Loop Power.

The Product recognizes and identifies the HART transmitter. When used with a Model 3051, the Product shows:

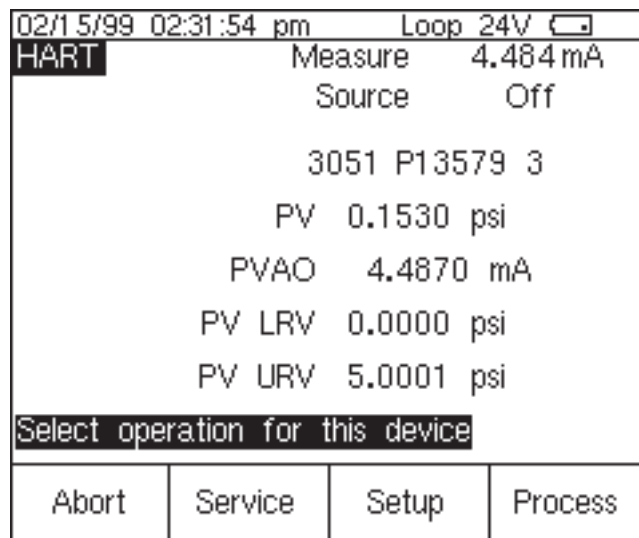

**Figure 14. Active Device Screen**

qb20s.bmp

The Active Device screen gives this data for all HART transmitters, supported or generic:

- Poll address (if not 0)
  - Model number and Tag ID
  - PV (Primary Variable)
  - PVAO (digital representation of the Analog Output)
  - PV LRV (PV Lower Range Value)
  - PV URV (PV Upper Range Value)
  - Softkeys for accessing HART operation menus
8. Communication to the HART transmitter has been established if step seven has been completed. The Product has passed the HART mode verification test.
  9. If the calibrator does not recognize the transmitter, the test has failed and Product repair is necessary. Speak to your nearest approved Fluke Service Center for servicing.

10. Disconnect all test equipment.

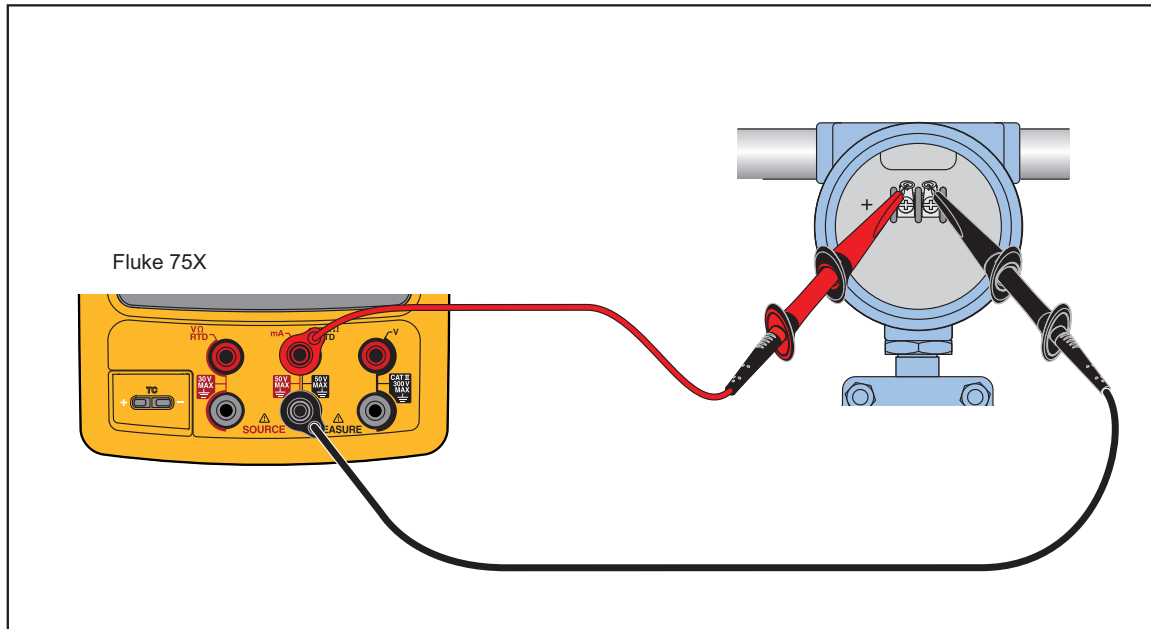

Figure 15. HART Mode Verification Connections

gks43.eps

## Calibration

Calibration is necessary only if the UUT does not pass verification. Always re-verify after calibration.

Calibration for the Product is done with internal software. There are no physical adjustments (except for three potentiometers used for common-mode error, explained later in this chapter). The subsequent instructions for calibration are minimal because of the built-in guided procedures. The internal software routines give step-by-step prompts for the correct stimulus or measurement. The guided procedures also illustrate which terminals (jacks) to use when you apply a stimulus, reading a measurement, or which terminals must be to be shorted with jumpers. Follow the instructions carefully to complete each calibration routine.

### Equipment Required for Calibration

The necessary accuracy of the source or measurement does not always correspond to the number of decimal places indicated on the UUT's display. For example, if you calibrate Frequency Measure, when the display requests a source value of 5.00000 V at 1.00000 kHz, the necessary accuracies are not of that magnitude. Use the measurement and source equipment suggested at the start of the Performance Verification Test.

### Calibration Status Indicator

The calibration display is accessed by when you push **SETUP** and then the **Prev. Page** softkey. At the top of the display is the Calibration Status followed by a number. This number moves forward after each subroutine is completed and the new constants are kept. When you do a complete calibration, the Product moves the Calibration Status by 4. Because the Calibration Status number is changed only by a re-calibration, it can be used to make sure that previous calibration constants have not been changed.

### How to Enter Calibration

In the calibration setup screen, push **F1** to calibrate. The calibration screen requests a password, 1234 is the default. After you put in the password, push **F4** to continue. The password is user-settable.



On the calibration screen, the step that has bolded text is the selected step.

Set Calibration Date sets the date that the Product shows for calibration at start-up. In most instances this is the date that the Product last passed the Performance Verification.

There are four adjustment procedures:

- Adjust Source
- Adjust Loop
- Adjust Measure
- Adjust Thermocouple

Each of these items shows the last time this step was completed.

- When you push the **Exit** softkey, the Product goes out of Calibration mode and starts.
- When you push the **Change Calibration Password** softkey the screen changes to the password screen.
- When you push the **Continue** softkey, the Product continues with the selected step.

### **Calibration Constant Out of Bounds**

If one or more of the calibration stimuli (or measurements) is out of range during a calibration routine, or the cabling is incorrect, the message [Error - Calibration Constant Out of Bounds] shows at the end of the routine. A general fault with the UUT can also be indicated by this error. The fault has to be corrected before you do the full sub-routine.

### **How to Calibrate**

Follow these general instructions for all calibrations:

- Operate the UUT on battery power. Make sure the battery is fully charged.
- Let each piece of calibration equipment meet its specified warm up period.
- Let the UUT warm up a minimum of 10 minutes.
- Source is only powered when it is used. A separate warm up for 10 minutes is necessary when you adjust source vdc, source ohms, source TC, source RTD, or source Hz. When you do a full adjust, a 10-minute warm up pause at the start of the volts dc source warms up the Product for all source steps.
- For each calibration, make sure the calibration equipment is stable and that the “unsettled” annunciator on the UUT is not shown.

Continue:

1. Turn on the UUT.
2. Push **SETUP** and then the **Prev. Page** softkey.
3. Push the **Calibrate** softkey to open the password screen
4. Input the password (the default password is 1234) and then push the **Continue** softkey.
5. Use **▲** and **D** to move the black text to the step to run. Push the **Continue** softkey to start a procedure

Each adjustment procedure will give connection instructions and signal levels needed for the step.

6. When the display prompts you for an input of 100.000 mV dc but shows an range

of  $90.0 \leq 100.000 \text{ mV} \leq 110.0.$ , apply the requested input, or apply an input in the allowed range. Use the numeric keys to add the value. Push the **Continue** softkey.

7. Apply the subsequent requested value as in step 5. Push the **Continue** softkey. When you record a negative value, always start with '-'.

 **Warning**

**Some of the voltages required for calibration are dangerous. To avoid injury or death from electric shock, do not touch live conductors during high-voltage calibration. Put the source device into Standby mode after each calibration step.**

8. Continue to apply voltages as necessary. Make sure you follow the connection instructions each time. Remember that the input jack configuration changes.
9. When you complete the last point in the subroutine, you are asked if you to keep the new constants. If you keep the new constants, the calibration constants are saved and the Calibration Status counter is incremented and the date is updated. If you discard the constants at this point, the calibration has no effect, the Calibration Status counter is not incremented, and the date does not change.



# static awareness



A Message From  
Fluke Corporation

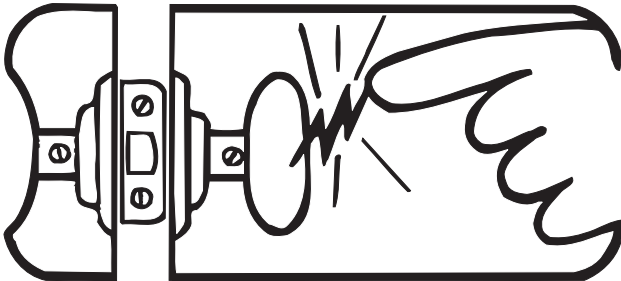

Some semiconductors and custom IC's can be damaged by electrostatic discharge during handling. This notice explains how you can minimize the chances of destroying such devices by:

1. Knowing that there is a problem.
2. Learning the guidelines for handling them.
3. Using the procedures, packaging, and bench techniques that are recommended.

The following practices should be followed to minimize damage to S.S. (static sensitive) devices.

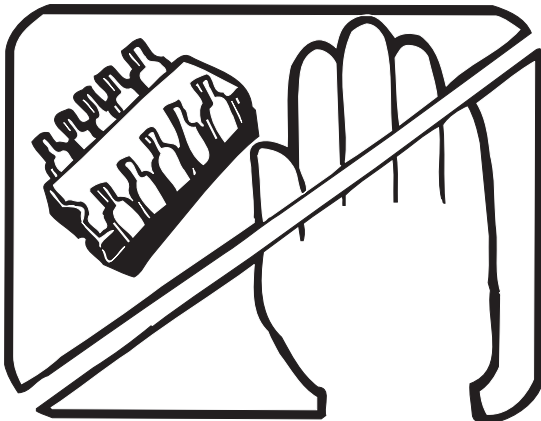

1. MINIMIZE HANDLING

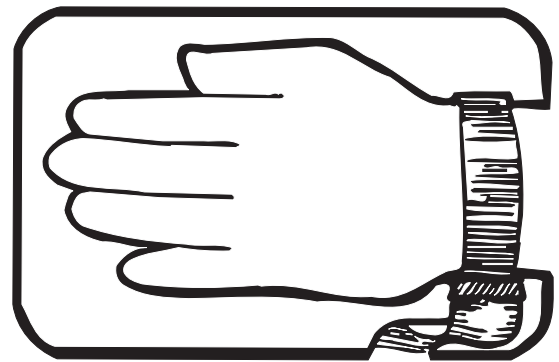

3. DISCHARGE PERSONAL STATIC BEFORE HANDLING DEVICES. USE A HIGH RESISTANCE GROUNDING WRIST STRAP.

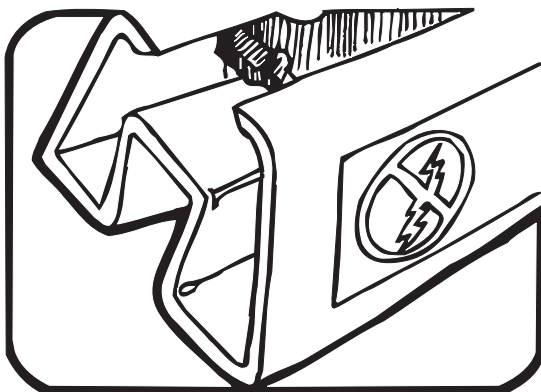

2. KEEP PARTS IN ORIGINAL CONTAINERS UNTIL READY FOR USE.

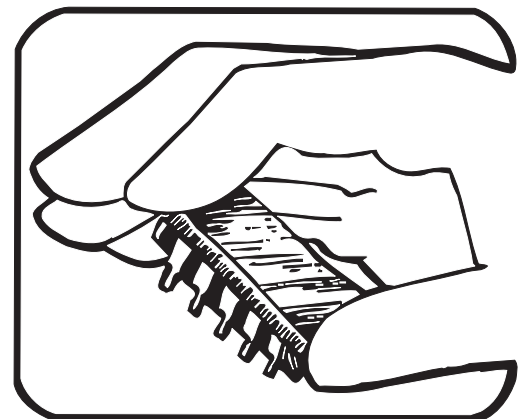

4. HANDLE S.S. DEVICES BY THE BODY.

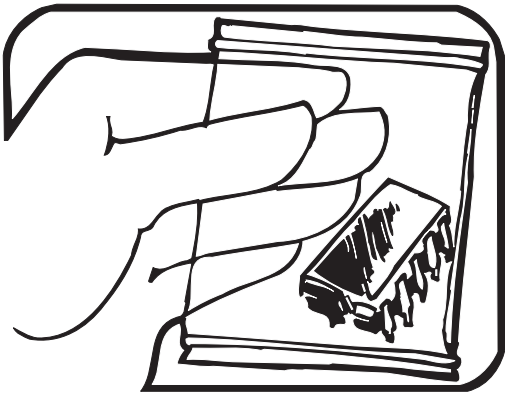

5. USE STATIC SHIELDING CONTAINERS FOR HANDLING AND TRANSPORT.

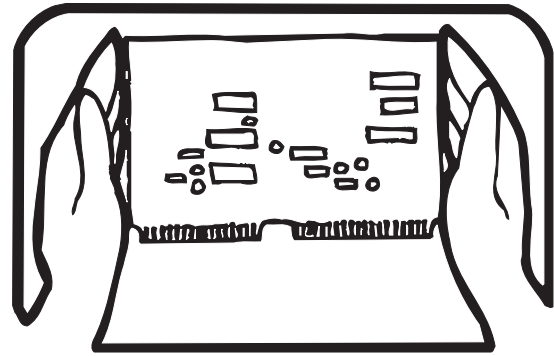

8. WHEN REMOVING PLUG-IN ASSEMBLIES HANDLE ONLY BY NON-CONDUCTIVE EDGES AND NEVER TOUCH OPEN EDGE CONNECTOR EXCEPT AT STATIC-FREE WORK STATION. PLACING SHORTING STRIPS ON EDGE CONNECTOR HELPS PROTECT INSTALLED S.S. DEVICES.

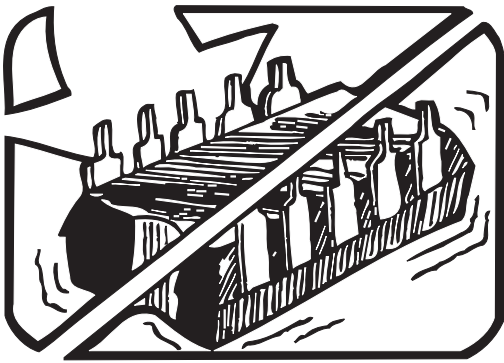

6. DO NOT SLIDE S.S. DEVICES OVER ANY SURFACE.

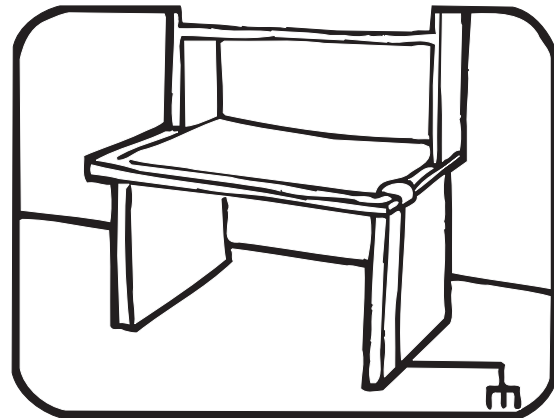

9. HANDLE S.S. DEVICES ONLY AT A STATIC-FREE WORK STATION.

10. ONLY ANTI-STATIC TYPE SOLDER-SUCKERS SHOULD BE USED.

11. ONLY GROUNDED-TIP SOLDERING IRONS SHOULD BE USED.

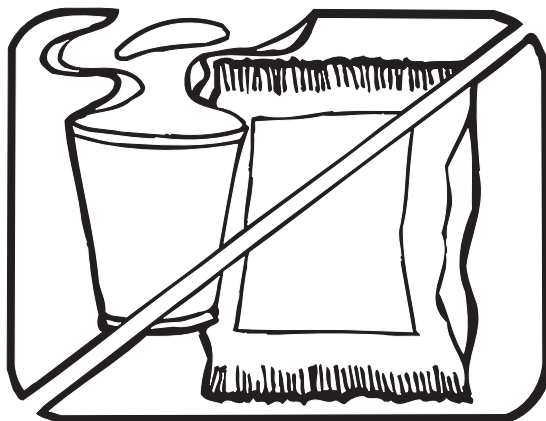

7. AVOID PLASTIC, VINYL AND STYROFOAM<sup>®</sup> IN WORK AREA.

PORTIONS REPRINTED  
WITH PERMISSION FROM TEKTRONIX INC.  
AND GERNER DYNAMICS, POMONA DIV.

## Maintenance

### Warning

To prevent possible electrical shock, fire, or personal injury:

- Have an approved technician repair the Product.
- Do not operate the Product with covers removed or the case open. Hazardous voltage exposure is possible.
- Remove the input signals before you clean the Product.
- Use only specified replacement parts.

### Battery Replacement

Replace the battery when it no longer holds a charge for the rated interval. The battery normally lasts for up to 300 charge/discharge cycles. To order a replacement battery, see “Contacting Fluke” and “Replaceable Parts”.

#### *Note*

*Spent batteries should be disposed of by a qualified recycler or hazardous materials handler. Contact an authorized Fluke Service Center for recycling information.*

### How to Clean the Product

Clean the Product and pressure modules with a soft cloth dampened with water or water and mild soap.

### Caution

To prevent possible damage to the Product, do not use solvents or abrasive cleansers.

### **Calibration Data**

The date of the last calibration and verification shows on the calibration sticker and on the calibration screen in Setup mode. The CAL. STATUS number on the sticker should always match the Calibration Status number in the calibration screen. Calibration of the Product is to be done by qualified personnel.

### **In Case of Difficulty**

#### **Warning**

**To avoid possible electric shock or personal injury, do not use the Product if it operates abnormally. Protection may be impaired. When in doubt, have the Product serviced.**

If the display is blank or unreadable, but the beeper works when the Product is turned on, make sure the brightness is correctly adjusted. To adjust the Intensity, see “Display Intensity” in the Users Manual.

If the Product will not turn on, make sure the battery is not dead or disconnected from the battery charger. If the Product receives power, the power button should be lit. If the button is lit, but the Product does not power up, have the Product serviced. See “How to Contact Fluke”.

### **Service Center Calibration or Repair**

Calibration, repairs, or servicing not included in this manual must be done only by qualified service personnel. If the Product fails, examine the battery pack first, and replace it if necessary.

Make sure that you operate the Product in accordance with the instructions in this manual. If the Product is faulty, send a description of the failure with the Product. Pressure modules do not need to accompany the Product unless the module is faulty also. Be sure to pack the Product securely, using the original shipping container if it is available. See “How to Contact Fluke” and the Warranty Statement.

## Replaceable Parts

Table 18 lists the customer replaceable parts. Replacement parts can be ordered from Fluke Corporation and its authorized representatives by using the part number. In the event that the part ordered has been replaced by a new or improved part, the replacement will be accompanied by an explanatory note and installation instructions, if necessary. See Figure 16.

**Table 18. Replacement Parts**

Reference Designator	754	754-SI	753	753-SI	Description
	Part Number	Part Number	Part Number	Part Number	
BT1	3409439	3409439	3409439	3409439	75x Battery, LI-ION, 7.2V, 4.4AH
DS1	3367520	3367520	3367520	3367520	LCD Module, 4.3 In Diag, 480xrgbx272 Pixels, LED Backlight
H1-H6	1558745	1558745	1558745	1558745	Screw, 5-14, .750, Pan, Black Chromate, Blunt Pt, Thread Form
H7-H16	3783203	3783203	3783203	3783203	Screw, M3x0.5, 6mm, Pan Head, Phillips, S-L Nylon Patch
H17-H28	642931	642931	642931	642931	Screw, 4-14, .312, Pan, Phillips, Thread Form, #3 Head
H29-H30	3469899	3469899	3469899	3469899	Nut, Slotted, M9 X 0.5 Thread
H30-H32	3469900	3469900	3469900	3469900	Washer, Locking, 12.5mm od
MP3	3369304	3369304	3369304	3369304	Fluke-75x, TC Isothermal PCA
MP4	3404752	3404752	3404752	3404752	Fluke-75x, Case Top
MP5	3404765	3404765	3404765	3404765	Fluke-75x, Case Bottom

Table 18. Replacement Parts (cont.)

Reference Designator	754	754-SI	753	753-SI	Description
	Part Number	Part Number	Part Number	Part Number	
MP6, MP7	3404776	3404776	3404776	3404776	Fluke-75x, Connector Cover
MP8	3404790	3404790	3404790	3404790	Fluke-75x, Tilt Stand
MP9			3948631	3948631	Fluke-753, Connector Bracket, Right
MP9	3404803	3404803			Fluke-754, Connector Bracket, Right
MP10	3404815	3404815	3404815	3404815	Fluke-75x, Connector Bracket, Left
MP11	3404826	3404826	3404826	3404826	Fluke-75x, Retainer, Isothermal Stopper
MP12	3404832	3404832	3404832	3404832	Fluke-75x, Stopper, Isothermal
MP13			3977652		Fluke-753, Mask
MP13				3981533	Fluke-753, Mask, SI
MP13	3439164				Fluke-754, Mask
MP13		3977665			Fluke-754, Mask, SI
MP14			3405856	3405856	Fluke-753, Decal, Case Top
MP14	3405856	3405856			Fluke-754, Decal, Case Top
MP15			3977713	3977713	Fluke-753, Keypad
MP15	3369430	3369430			Fluke-754, Keypad
MP17-MP19	884259	884259	884259	884259	Input Receptacle Insulator (Black)
MP20-MP22	884254	884254	884254	884254	Input Receptacle Insulator (Red)
MP23	3478081	3478081	3478081	3478081	Fluke-75x, Foam, Dust Seal



**Table 18. Replacement Parts (cont.)**

Reference Designator	754	754-SI	753	753-SI	Description
	Part Number	Part Number	Part Number	Part Number	
MP24	3477901	3477901	3477901	3477901	Fluke-75x, Battery Compartment Foam Pad
MP25	3440115	3440115	3440115	3440115	Fluke-75x, LCD Shock Absorber
MP44-MP45	3450124	3450124	3450124	3450124	Fluke-75x, TC Isothermal Spring

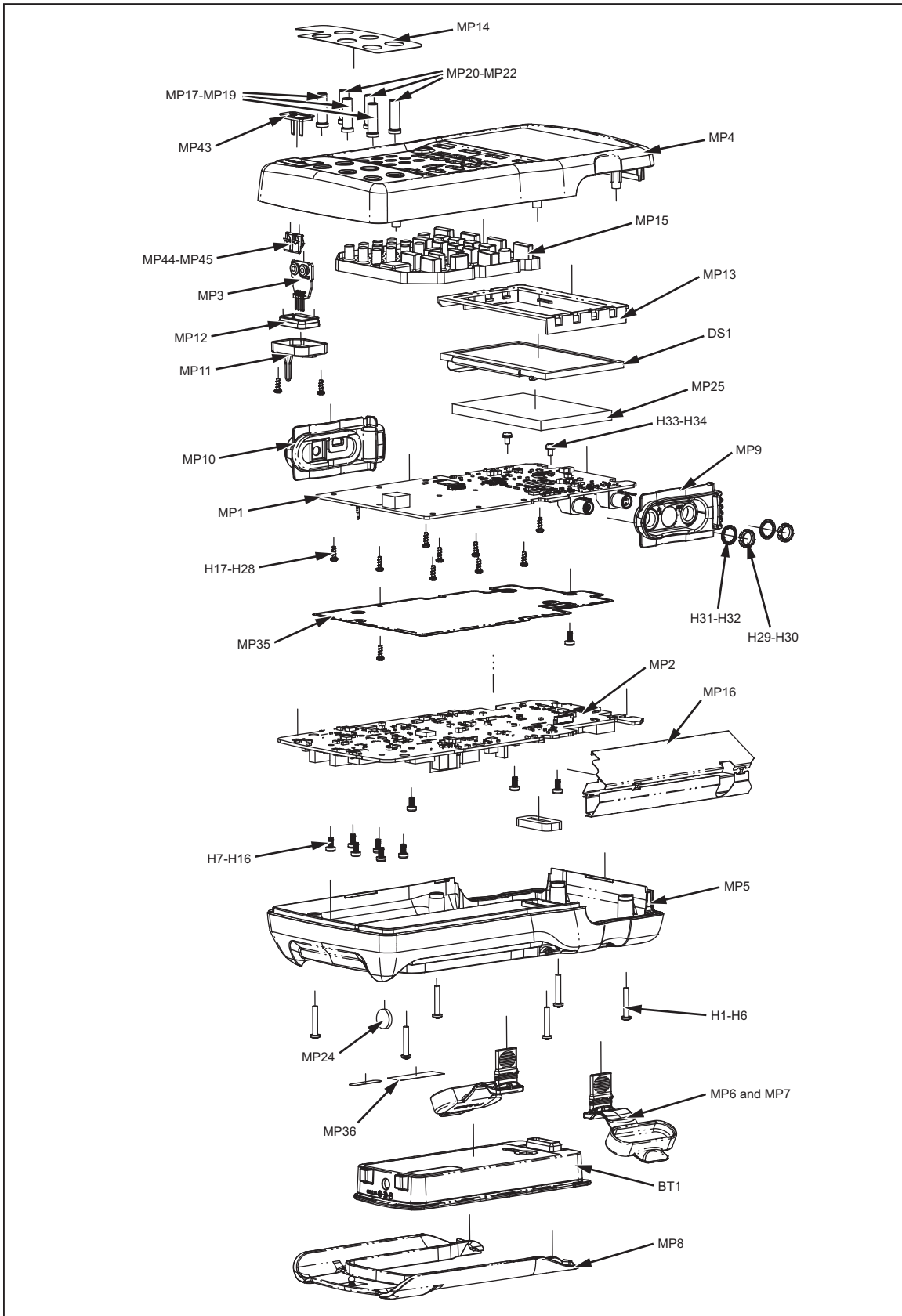

Figure 16. Parts

gs016.eps

## Accessories

Accessories for the Product are listed in Table 19.

**Table 19. Accessories**

<b>Batteries, Chargers and Adapters</b>	
BC7240	Battery Charger/Eliminator
BP7240	Li-Ion Battery Pack
<b>Cases-Holsters</b>	
C700	Hard Case (700 Series)
C781	Soft Meter Case
C799	Soft Field Case
<b>Test Leads Probes and Clips</b>	
AC220	SureGrip™ Alligator Clips
700TLK	Fluke 700TLK Process Test lead kit
AC280	SureGrip™ Hook Clips
AC285	SureGrip™ Alligator Clips
TL940	Mini-Hook Test Leads
TL950	Mini-Pincer Test Leads
TP74	Lantern Tip Test Probes
TP920	Test Probe Adapter Set
754HCC	Hart Communication Cable, 754
1671807	USB-A(M), USB-MINI-B(M), Shielded, 2M
944632	Test Lead, 1KV/CATII, 10cm, Black

